



DOOR
HARDWARE

HIR-

DA-

VAT

HAKKIMIZDA

About Us

BALCIOĞLU HIRDAVAT A.Ş 35 m² eski sanayi bölgesinde kurulmuş olup zaman içerisinde Organize sanayi bölgesinde 5.000 m² alana ve birikim, tecrübe ve müşterilerimizin gücü ile 14.000 m² (9.000 m² Kapalı) alanda faaliyet gösteren sektöründe lider konumunda ilkeli, müşteri odaklı bir firma olarak faaliyetimize devam etmekteyiz. Önceliğini kaliteye, güvenliğe, temiz ve sağlam işçiliğe, üstün hizmet anlayışına ve günden güne gelişerek kendini sizler için daha da ileriye taşımaya amaçlamıştır. Sektöründe lider bir çok üretici firmanın ana bayiliği ile binlerce ürün çeşidi ile geniş çeşit uygun fiyatlarla müşterilerimize sunuyoruz.

Kendi bünyemizde bulunan Alüminyum Kaplama tesisi ve Alüminyum işleme tesisimizle sektörümüz ile alakalı müşterilerimize hizmet ve ürün ile hizmet vermekteyiz. Balcıoğlu Hırdavat; gelişmiş sistemleri ile her gün daha iyi işler ortaya koymuş ve her geçen gün ürünlerine bir yenisini daha eklemek için çabalamıştır. Özgün tasarım, ürün çeşitliliği, yapısal sağlamlık ve zarafetin bir arada bulunduğu, ileri dönük birçok projeyi ve işinde uzman kadroyu bünyesinde barındıran firma sadece yarını değil çok daha ilerisini hedefleyen, büyük firmalar arasına adını yazdırmak isteyen yenilikçi bir firmadır.



SHOWROOM

showroom



KAPI KİLİT GRUBU DOOR LOCK	08
KENDİ ÜRETİMİMİZ OWN PRODUCTION	68
KAPI KOLLARI DOOR HANDLES	84
KAPI TAKTAKLARI DOOR KNOCKERS	108
ANTİK GRUP ANTIQUÉ GROUP	112
ÇELİK ROZET VE TAS GRUBU STEEL BADGE AND BALL GROUP	116
KELEPÇE GRUBU CLAMP GROUP	120
DÜRBÜN VE İSİMLİK GRUBU THE FOOTBALL AND NAME GROUP	126
PANİK BAR VE YANGIN MALZEMELERİ PANIC BAR AND FIRE MATERIALS	130
KAPI FİTİLLERİ DOOR SEALS	142
MENTEŞE GRUBU HINGE GROUP	148
DİĞER ÜRÜN GRUBU OTHER PRODUCT GROUP	158

İN Çİ

Content



KAPI
DOOR LOCK
GROUP

Kilit GRUBU

ÇELİK KAPI KİLİTLERİ

Steel Door Locks

MONOBLOK ÇELİK KAPI GÖMME KİLİDİ.
RULMANLI.

MORTISE LOCK FOR STEEL DOORS. WITH
BALL BEARING.

252 R



257

PLUS ÇELİK KAPI GÖMME EMNİYET KİLİDİ.
SAFETY MORTISE LOCK FOR STEEL DOORS.



ÇELİK KAPI KİLİTLERİ

Steel Door Locks

MONOBLOK ÇELİK KAPI GÖMME KİLİDİ.
RULMANLI.

MORTISE LOCK FOR STEEL DOORS. WITH
BALL BEARING.

252 RA



Yardımcı Kilit
Auxiliary Latch



KALE
OTOMATİK

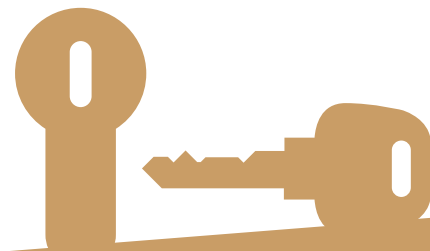

ÇELİK KAPI KİLİTLERİ

Steel Door Locks

FİŞELİ ÇELİK KAPI GÖMME KİLİT SETİ.

DOUBLE-BIT KEY MORTISE LOCK SET FOR STEEL DOORS.

252 RL SET

> Ortak anahtarlı (3 adet)
(Opsiyonel 5 anahtarlı)

> Keyed Alike (3 Pieces)
(Optional 5 keys)



3 anahtar
(Opsiyonel 5 anahtar)

3 keys
(Optional 5 keys)



ÇELİK KAPI KİLİTLERİ

Steel Door Locks

MULTİSİSTEM YARI MERKEZİ SİSTEM ÇELİK KAPI KİLİDİ.
RULMANLI

MULTI-POINT SEMI-CENTRAL LOCKING SYSTEM FOR STEEL DOORS.
WITH BALL BEARING.

252 RYM

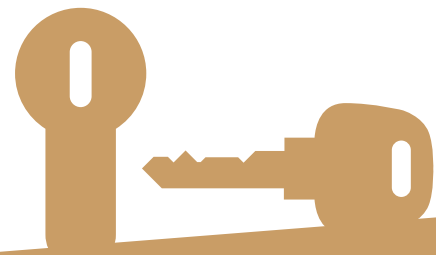

ÇELİK KAPI KİLİTLERİ

Steel Door Locks

256 G

MULTİSİSTEM MERKEZİ ÇELİK KAPI KİLİDİ. GİZLİ EMNİYET KELEPÇELİ. RULMANLI.

MULTI-POINT CENTRAL LOCKING SYSTEM FOR STEEL DOORS. WITH CONCEALED DOOR RETAINER. WITH BALL BEARING.



ÇELİK KAPI KİLİTLERİ

Steel Door Locks

256

MULTİSİSTEM MERKEZİ ÇELİK KAPI KİLİDİ. RULMANLI.

MULTI-POINT CENTRAL LOCKING SYSTEM FOR STEEL DOORS. WITH BALL BEARING.

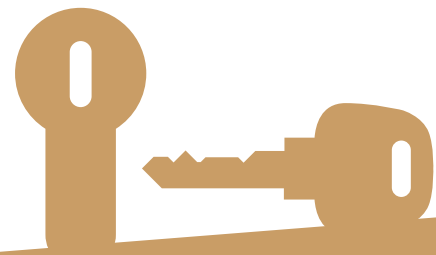

ÇELİK KAPI KİLİTLERİ

Steel Door Locks

CHAMPION KANCALI ÇELİK KAPI GÖMME KİLİDİ.
RULMANLI

MORTISE LOCK WITH CLAW TYPE DEADBOLT FOR STEEL DOORS.
WITH BALL BEARING.

262 R



267

CHAMPION KANCALI ÇELİK KAPI GÖMME EMNİYET KİLİDİ.
RULMANLI

SAFETY MORTISE LOCK WITH CLAW TYPE DEADBOLT
FOR STEEL DOORS. WITH BALL BEARING.



ÇELİK KAPI KİLİTLERİ

Steel Door Locks

CHAMPION KANCALI ÇELİK KAPI GÖMME KİLİDİ.
RULMANLI

MORTISE LOCK WITH REVERSE CLAWS FOR STEEL DOORS.
WITH BALL BEARING.

292 R



297

CHAMPION KANCALI ÇELİK KAPI GÖMME EMNİYET KİLİDİ.
RULMANLI

SAFETY MORTISE LOCK WITH REVERSE CLAWS.
FOR STEEL DOORS.

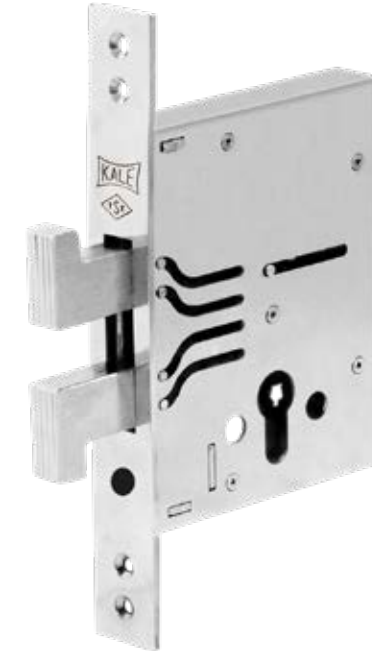

ÇELİK KAPI KİLİTLERİ

Steel Door Locks

CHAMPION KANCALI ÇELİK KAPI GÖMME KİLİDİ.
RULMANLI

MORTISE LOCK WITH CLAW TYPE DEADBOLD FOR STEEL DOORS.
WITH BALL BEARING.

276



ÇELİK KAPI KİLİTLERİ

Steel Door Locks

CHAMPION MULTİSİSTEM MERKEZİ KANCALI ÇELİK KAPI KİLİDİ.
RULMANLI

MULTI-POINT CENTRAL LOCKING SYSTEM WITH CLAW TYPE
DEADBOLT FOR STEEL DOORS. WITH BALL BEARING.

276 T



277

CHAMPION KANCALI ÇELİK KAPI GÖMME EMNİYET KİLİDİ.
RULMANLI

SAFETY MORTISE LOCK WITH CLAW TYPE DEADBOLT
FOR STEEL DOORS. WITH BALL BEARING.

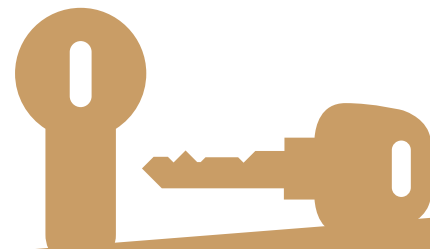

ÇELİK KAPI KİLİTLERİ

Steel Door Locks

252 EM

TEKNİK BİLGİLER:
GÖVDE: ÇELİK GALVANİZ KAPLAMALI.
AYNA VE KARŞILIK: ÇELİK KROM KAPLAMALI.
MANDAL: SİNER, KROM KAPLAMALI.
SERTİFİKALAR: TS EN 14846
PİL GERİLİM DEĞERİ: 1.5 V AA X 4 (6 V)
HARİCİ GERİLİM DEĞERİ: EXTERNAL POWER LEVEL : 12 V DC (KABLOLU BAĞLANTI İÇİN)
PİL ÖMRÜ: 1 YIL (ORTALAMA KULLANIM)
ÇALIŞMA SICAKLIĞI: -20°C / +60°C
DEPOLAMA SICAKLIĞI: 0°C / +50°C
NEM: 0 - %85 RH

TECHNICAL INFORMATION:
CASE: STEEL GALVANIZED.
FOREND PLATE AND STRIKING: STEEL CHROME PLATED.
LATCH: SINTER CHROME PLATED.
CERTIFICATIONS: TS EN 14846
BATTERY POWER LEVEL: 1.5 V AA X 4 (6 V)
EXTERNAL POWER LEVEL: 12 V DC (FOR CABLE CONNECTION)
BATTERY LIFE: 1 YEAR (AVERAGE USE)
WORKING TEMPERATURE: -20°C / +60°C
STORAGE TEMPERATURE: 0°C / +50°C
HUMIDITY: 0 - %85 RH

Kale Akıllı Çelik Kapı Kilidi ile
anahtara ihtiyaç duymadan kapınızı akıllı mobil telefonunuz ile açın

Kale Smart Lock for Steel Doors
allows you to access your door with your smart phone



Mobil Anahtar paylaşımı ile dilediğiniz kişiye sınırlı/sınırsız geçiş izni
Issue mobile keys for your visitors via smart phone



İstenilen zaman aralığında giriş yetkisi verebilme
Grant visitors time limited/unlimited access



Elektronik Geçiş Kontrol Sistemleri ile uyumlu
Can easily integrate with Electronic Access Control System:



Kapı kapandığında otomatik kilitleme
Automatic locking when the door is closed



Kapı koluna basılarak içeriden kolayca çıkış sağlar
Easy exit with Panic Function

ÇELİK KAPI KİLİTLERİ

Steel Door Locks

356 MULTI

TEKNİK BİLGİLER:
GÖVDE: ÇELİK GALVANİZ KAPLAMALI.
AYNA VE KARŞILIK: ALKALİ ÇİNKO KAPLAMALI.
SÜRGÜ: ÇELİK NİKEL KAPLAMALI DOKUZ MİLLİ.
MANDAL: PİRİNÇ NİKEL KAPLAMALI.
YÖN: ÇEVİRİLEBİLİR.
SERTİFİKALAR: TS EN 12209

TECHNICAL INFORMATION:
CASE: STEEL GALVANIZED.
FOREND AND STRIKING PLATE: ALKALI ZINC PLATED.
DEADBOLT: STEEL NICKEL PLATED NINE BARS.
LATCH: BRASS NICKEL PLATED.
DIRECTION: REVERSIBLE.
CERTIFICATIONS: TS EN 12209.

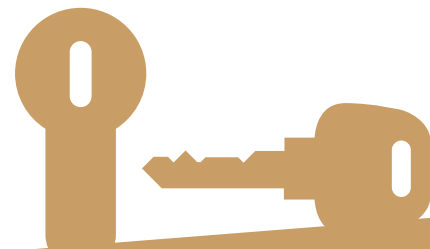

ÇELİK KAPI KİLİTLERİ

Steel Door Locks

DÖNER SÜRGÜLÜ ÇELİK KAPI GÖMME KİLİDİ.
RULMANLI.

MORTISE LOCK ROTATING DEADBOLT FOR STEEL DOORS.
WITH BALL BEARING.

282 RD



287

DÖNER DÜRGÜLÜ ÇELİK KAPI GÖMME EMNİYET KİLİDİ.
SAFATY MORTISE LOCK WITH ROTATING DEADBOLT
FOR STEEL DOORS.



SİLİNDİRLİ GÖMME KİLİTLER

Mortise Lock With Cylinder

152/3MR

SİLİNDİRLİ GÖMME KİLİT (GENİŞ TİP.)
AHŞAP KAPILAR İÇİN.
RULMANLI.

MORTISE LOCK WITH
CYLINDER (WIDE TYPE.)
FOR WOODEN DOORS.
WITH BALL BEARING.



152 RP

SİLİNDİRLİ GÖMME KİLİT (GENİŞ TİP.)
PVC KAPILAR İÇİN.
RULMANLI.

MORTISE LOCK WITH
CYLINDER (WIDE TYPE.)
FOR PVC DOORS.
WITH BALL BEARING.



152 R

SİLİNDİRLİ GÖMME KİLİT (GENİŞ TİP.)
PVC KAPILAR İÇİN.
RULMANLI.

MORTISE LOCK WITH
CYLINDER (WIDE TYPE.)
FOR PVC DOORS.
WITH BALL BEARING.



SİLİNDİRLİ GÖMME KİLİTLER

Mortise Lock With Cylinder

155 B

İÇ KAPI GÖMME KİLİDİ.
ALÜMİNYUM WC KAPILAR İÇİN.

INTERIOR MORTISE LOCK.
FOR ALUMINIUM WC DOORS.



153

SİLİNDİRLİ GÖMME KİLİT (DAR TİP.)
ALÜMİNYUM ÇARPMA KAPILAR İÇİN.
KARŞILIKSIZ VE ROZETSİZ.

MORTISE LOCK WITH CYLINDER (NARROW TYPE.)
FOR ALUMINIUM SWINGING DOORS.
WITHOUT STRIKING PLATE AND ROZETTE



155

SİLİNDİRLİ GÖMME KİLİT (DAR TİP.)
ALÜMİNYUM KAPILAR İÇİN. KARŞILIKSIZ VE ROZETSİZ.

MORTISE LOCK WITH CYLINDER (NARROW TYPE.)
FOR ALUMINIUM DOORS. WITHOUT STRIKING PLATE AND ROZETTE



154

SİLİNDİRLİ GÖMME KİLİT (GENİŞ TİP.)
AĞAÇ ÇARPMA KAPILAR İÇİN.

MORTISE LOCK WITH CYLINDER (WIDE TYPE.)
FOR WOODEN SWINGING DOORS.



SİLİNDİRLİ GÖMME KİLİTLER

Mortise Lock With Cylinder

189 3-MF

PAZIS SİLİNDİRLİ GÖMME KİLİDİ.
AĞAÇ VE METAL KAPILAR İÇİN.

SAFETY MORTISE LOCK WITH CROSS KEY TYPE CYLINDER.
FOR WOODEN AND METAL DOORS.



189 3M

SİLİNDİRLİ GÖMME KİLİDİ.
AĞAÇ VE METAL KAPILAR İÇİN.

SAFETY MORTISE LOCK WITH CYLINDER
FOR WOODEN AND METAL DOORS.



189 4-MF

PAZIS SİLİNDİRLİ GÖMME EMNİYET KİLİDİ.
AĞAÇ VE METAL KAPILAR İÇİN.

SAFETY MORTISE LOCK WITH CROSS KEY TYPE CYLINDER.
FOR WOODEN AND METAL DOORS.



DIŐAN TAKMA TİRAJLI KİLİTLER

Surface Mount Rim Locks

157 ABC

DIŐAN TAKMA TİRAJLI KİLİT / NO: 14-10-12.
AŐAP VE METAL KAPILAR İÇİN. SABİT VEYA KOVANLI STANDART SİLİNDİRLİ.

SURFACE MOUNT RIM LOCK / NO: 14-10-12.
FOR WOODEN AND METAL DOORS. WITH FIXED OR LOOSE STANDARTD CYLINDER

2001 ABC

DIŐAN TAKMA TİRAJLI KİLİT / NO: 14-10-12.
AŐAP VE METAL KAPILAR İÇİN. SABİT SİSTEM SİLİNDİRLİ.

SURFACE MOUNT RIM LOCK / NO: 14-10-12.
FOR WOODEN AND METAL DOORS. WITH FIXED SYSTEM CYLINDER



A 3M/C 3M

DIŐAN TAKMA TİRAJLI KİLİT / NO: 14-12.
AŐAP VE METAL KAPILAR İÇİN.
SABİT VEYA KOVANLI STANDART SİLİNDİRLİ.

SURFACE MOUNT RIM LOCK / NO: 14-12.
FOR WOODEN AND METAL DOORS.
WITH FIXED OR LOOSE STANDARTD CYLINDER



157 AE

DIŐAN TAKMA TİRAJLI KİLİT / NO: 14
AŐAP VE METAL KAPILAR İÇİN. SABİT VEYA KOVANLI
STANDART SİLİNDİRLİ.

SURFACE MOUNT RIM LOCK / NO: 14
FOR WOODEN AND METAL DOORS. WITH FIXED OR LOOSE
STANDARTD CYLINDER



DIŐAN TAKMA TİRAJLI KİLİTLER

Surface Mount Rim Locks

357 MS

KALE OTOMAT/DIŐAN TAKMA ELEKTRİKLİ TİRAJLI KİLİT.
AŐAP VE METAL KAPILAR İÇİN. BUTONLU. MAKARALI.

KALE SURFACE MOUNT ELECTRICAL RIM LOCK.
FOR WOODEN AND METAL DOORS. WITH PUSH BUTTON. WITH ROLLER.



357 M

KALE OTOMAT/DIŐAN TAKMA ELEKTRİKLİ TİRAJLI KİLİT.
AŐAP VE METAL KAPILAR İÇİN. BUTONLU. SİLİNDİRLİ MAKARALI.

KALE SURFACE MOUNT ELECTRICAL RIM LOCK.
FOR WOODEN AND METAL DOORS. WITH PUSH BUTTON.
WITH CYLINDER. WITH ROLLER.



İÇ KAPI GÖMME KİLİTLERİ

Interior Mortise Locks

141 R

İÇ KAPI GÖMME KİLİDİ (GENİŞ TİP.) RULMANLI
AHŞAP KAPILAR İÇİN. ROZETLİ KAPI KAOLUNA UYGUN KİLİT.
INTERIOR MORTISE LOCK (WIDE TYPE) WITH BALL BEARING.
FOR WOODEN DOORS. COMPATIBLE WITH DOOR HANDLE ESCUTCHEON.



151 R

İÇ KAPI GÖMME KİLİDİ. (GENİŞ TİP.)
PVC KAPILAR İÇİN. RULMANLI.
INTERIOR MORTISE LOCK. (WIDE TYPE).
FOR PVC DOORS. WITH BALL BEARING.



149 R WC

İÇ KAPI GÖMME KİLİDİ. (GENİŞ TİP.) RULMANLI.
AHŞAP WC KAPILAR İÇİN. ROZETLİ KAPI KOLUNA UYGUN KİLİT.
INTERIOR MORTISE LOCK. (WIDE BALL BEARING).
FOR WOODEN WC DOORS. COMPATIBLE WITH DOOR
HANDLE ESCUTCHEON.



169 R WC

İÇ KAPI GÖMME KİLİDİ. (GENİŞ TİP.)
AHŞAP WC KAPILAR İÇİN. RULMANLI.
INTERIOR MORTISE LOCK. (WIDE TYPE.)
FOR WOODEN WC DOORS. WITH BALL BEARING.



İÇ KAPI GÖMME KİLİTLERİ

Interior Mortise Locks

201

ÇELİK GALVANİZ KAPLAMALI. ÇELİK NİKEL KAPLAMALI.
ZAMAK DÖKÜM. KROM KAPLAMALI. TEK TURLU.
SERTİFİKALAR: TS EN 12209.
STEEL GALVANIZED COATED. IT IS COATED WITH STEEL NICKEL.
ZINC ALLOY. CHROME PLATED. ONE ROUND.
CERTIFICATES: TS EN 12209.



251

İÇ KAPI GÖMME KİLİDİ
AHŞAP KAPILAR İÇİN. ANAHTARSIZ
INTERIOR MORTISE LOCK
FOR WOODEN DOORS. WITHOUT KEY.



201 F

ÇELİK GALVANİZ KAPLAMALI. ÇELİK NİKEL KAPLAMALI.
ZAMAK DÖKÜM. KROM KAPLAMALI. TEK TURLU.
3 ADET. (OPSİYONEL 5 ADET). TS EN 12209.
STEEL GALVANIZED COATED. STEEL NİKEL COATED.
ZINC ALLOY. CHROME PLATED. ONE ROUND.
3 PIECES. (OPTIONAL 5). TS EN 12209.



SESSİZ SERİ VE MIKNATISLI KİLİTLER

Silent Series and Magnetic Locks

221

SESSİZ SERİ KLASİK İÇ KAPI
GÖMME KİLİDİ 50MM

SLENT SERIES CLASSICAL INTERIOR
MORTISE LOCK



222

SESSİZ SERİ KLASİK
SİLİNDİRLİ KİLİT 50 MM

SLENT SERIES CYLINDER
CLASSIC SERIES



229 WC

SESSİZ SERİ KLASİK
BANYO - WC GÖMME KİLİDİ 50MM

SILENT SERIES CLASSICAL
BATHROOM MORTISE LOCK 50MM



PRATİK MIKNATISLI KİLİTLER

Silent Series and Magnetic Locks

241

PRATİK KLASİK İÇ KAPI
GÖMME KİLİDİ 50MM

PRACTICAL CLASSIC INTERIOR DOOR
MORTISE LOCK 50MM



242

PRATİK KLASİK İÇ KAPI
SİLİNDİRLİ KİLİT 50 MM

PRACTICAL CLASSIC INTERIOR DOOR
LOCK WITH CYLINDER 50 MM



249 WC

PRATİK KLASİK
BANYO - WC GÖMME KİLİDİ 50MM

PRACTICAL CLASSIC
BATH - WC MORTISE LOCK 50MM



SESSİZ SERİ VE MIKNATISLI KİLİTLER

Silent Series and Magnetic Locks

231 NN

SESSİZ SERİ NEODYUM MIKNATISLI
İÇ KAPI GÖMME KİLİDİ 50MM

SILENT SERIES NEODYUM MAGNETIC
INTERIOR MORTISE LOCK 50MM



232 NN

SESSİZ SERİ NEODYUM MIKNATISLI
SİLİNDİRLİ GÖMME KİLİDİ 50MM

SILENT SERIES NEODYUM MAGNETIC
INTERIOR MORTISE LOCK WITH CYLINDER 50MM



239 WC NN

SESSİZ SERİ NEODYUM MIKNATISLI
BANYO - WC GÖMME KİLİDİ 50MM

SILENT SERIES NEODYUM MAGNETIC
BATHROOM MORTISE LOCK 50MM



SİLİNDİRLER

Cylinders

164 CG

SİLİNDİR TOPUZUNUN HAREKETİNİ SAĞ VE SOL YÖNE
ÇEVİRİMİNİ KISITLAYAN AYAR YUVASI.

ADJUSTMENT HOLES FOR RESTRICTING THE ROTATE OF CYLINDER
THUMBTURN IN RIGHT OR LEFT DIRECTION.



164 OBS BE

OTOMATİK BLOKAJ SİSTEMİ. SİSTEM SİLİNDİR.
AUTOMATIC BLOCKAGE SYSTEM. SYSTEM CYLINDER.



164 ASM

KALE ALARMLI SİLİNDİR. SİSTEM SİLİNDİR.
KALE ALARM CYLINDER. SYSTEM CYLINDER.

(*) Bu özellik tek kullanımlık olup kullanıcıyı en az
6 yıl boyunca, yalnız silindirin kırılması (tuzak kısmı)
ile meydana gelebilecek hırsızlık girişimlerine karşı
caydırıcı amaçlı olarak kapı iç ve dış ortama doğru
10 cm mesafeden 80dB ses seviyesi ile uyarılmak
amacıyla tasarlanmıştır.

(*) This feature is single use only and it is designed
to dissuade the burglary attempts that only include
snapping the cylinder (on its sacrificial cut) by
activating the alarm with the sound of 80db within
10 cm range towards the inner and outer part of the
door. The protection period of alarm is minimum
6 years.



164 OBS G

OTOMATİK BLOKAJ SİSTEMİ. SİSTEM SİLİNDİR.
AUTOMATIC BLOCKAGE SYSTEM. SYSTEM CYLINDER.



164 BNE

BİLYALI SİLİNDİR EMNİYET KARTLI.
HIGT SECURITY CYLINDER.
WITH REGISTRATION CARD.



164 SNC

SİSTEM SİLİNDİR.
SYSTEM CYLINDER.



164 BME

BİLYALI MANDALLI SİLİNDİR. EMNİYET KARTLI
BALL LATCHED CYLINDER. SAFETY CARD



164 SMC

SİSTEM MANDALLI SİLİNDİR.
THE SYSTEM IS CYLINDER WITH LATCH.



164 GNC

STANDART SİLİNDİR.
STANDARD CYLINDER.



164 BR-GR-SR

YARIM TİP SİLİNDİR.
BİLYALI, STANDART, SİSTEM SİLİNDİR.
HALF TYPE CYLINDER.
HIGH SECURITY, STANDARD, SYSTEM CYLINDER.



164 GMC

STANDART MANDALLI SİLİNDİR.
STANDARD LATCHED CYLINDER.



164 GMC

YARIM MANDALLI TİP SİLİNDİR.
HALF LATCH TYPE CYLINDER.



164 CEC

KALE TÜPTEN ŞİFRELI YÜKSEK GÜVENLİKLİ SİLİNDİR. EMNİYET KARTLI.

KALE ADVANCED SECURITY CYLINDER WITH CORE POSITIONED PINS. WITH REGISTRATION CARD.

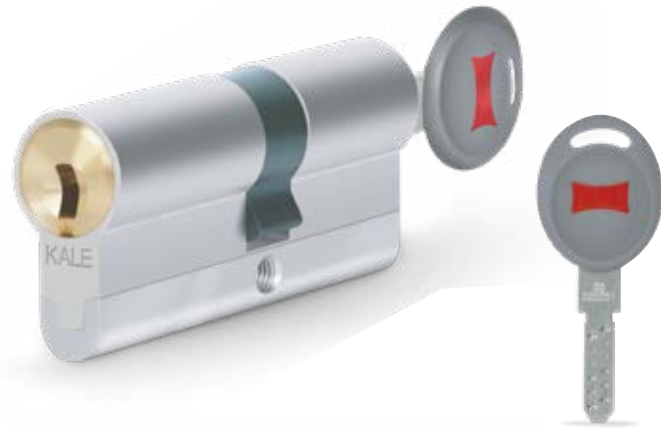

164 YGS SE

YÜKSEK GÜVENLİKLİ SİLİNDİR. SİSTEM SİLİNDİR. EMNİYET KARTLI.

ADVANCED SECURITY CYLINDER. SYSTEM CYLINDER. WITH REGISTRATION CARD.



Çelik U Profil
Steel U Profile

232 KTB G

KALE TUZAKLI SİLİNDİR. STANDART SİLİNDİR. KALE TRAP CYLINDER. STANDARD CYLINDER.



164 KTB S

KALE TUZAKLI SİLİNDİR. SİSTEM SİLİNDİR. KALE TRAP CYLINDER. SYSTEM CYLINDER.

164 KIS

KALE İKAZ SİLİNDİRİ
KALE ALERT CYLINDER



Girişte ve çıkışta anahtar kapıda unutulduğunda
It the key is forgotten on the door at the entry and exit

8 saniye içinde devreye girer*
Alarm runs up in 8 seconds

Alarm 100 dBA ses ile sizi uyarır
Alarm emits 100 dBA alert sound

Farklı renklerde şık ve plastik kafalı anahtarlar
With coloured and stylish plastic-headed keys

164 DSN

ÇELİK TAKVİYELİ SİLİNDİR. SİSTEM SİLİNDİR. TEAR-RESISTANT CYLINDER. SYSTEM CYLINDER.



164 DGN

ÇELİK TAKVİYELİ SİLİNDİR. STANDART SİLİNDİR. TEAR-RESISTANT CYLINDER. STANDARD CYLINDER.



SİLİNDİRLER

Cylinders

164 OBS-BNE Z

YÜKSEK GÜVENLİKLİ İNŞAAT SİLİNDİRİ.
EMNİYET KARTLI.

HIGH SECURITY CONSTRUCTION CYLINDER.
WITH REGISTRATION CARD.



164 GS-GSC

STANDART SİLİNDİR. ACİL DURUM FONKSİYONLU.
SİLİNDİRİN BİR TARAFINDA ANAHTAR TAKILI OLSA BİLE
DİĞER TARAFINDAN ANAHTAR İLE AÇILABİLME.

STANDART CYLINDER WITH EMERGENCY FUNCTION.
OPERABLE BY KEY EVEN IF A KEY IS INSERTED INTO
OTHER SIDE OF THE CYLINDER.

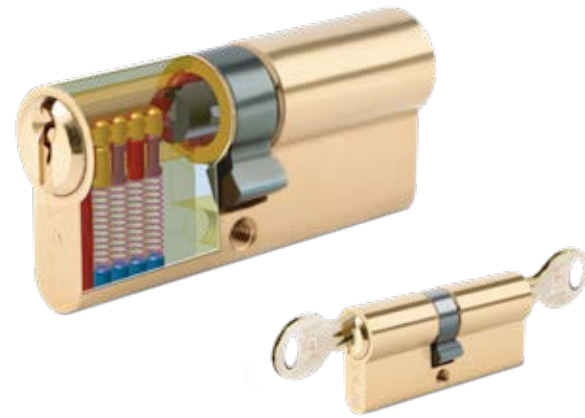

164 DBNE

ÇELİK TAKVİYELİ SİLİNDİR.
BİLYALI SİLİNDİR EMNİYET KARTLI.

TEAR-RESISTANT CYLINDER.
HIGH SECURITY CYLINDER
WITH REGISTRATION CARD.



Paslanmaz çelik takviyeli
Stainless steel reinforcement.

164 OBS BE

OTOMATİK BLOKAJ SİSTEMİ. BİLYALI SİLİNDİR.
EMNİYET KARTLI.

AUTOMATIC BLOCKAGE SYSTEM. HIGH SECURITY CYLINDER.
WITH REGISTRATION CARD.



Otomatik blokaj pimleri
Automatic blockage pins

KALE MASTER SİSTEM

Kale Master System

KMS



BÜYÜK GENEL MASTER ANAHTARI
GREAT GRAND MASTER KEY (GGMK)

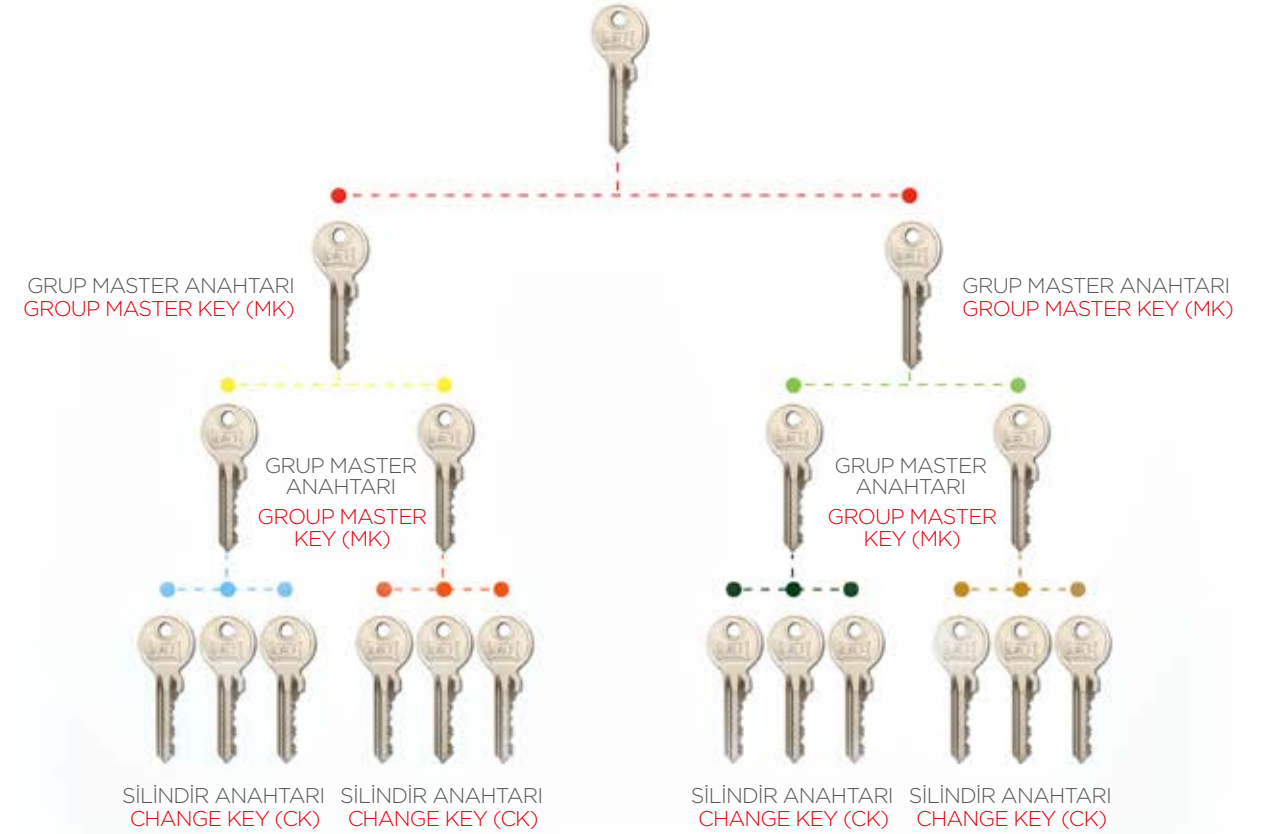

BLİSTER AMBALAJLI KİLİTLER

Locks In Blister Pack



ÇELİK KAPI KİLİTLERİ

Steel Door Locks

HOK
KİLİTLERİ

CC 9001

MONOBLOK ÇELİK KAPI GÖMME KİLİDİ.
RULMANLI.

MORTISE LOCK FOR STEEL DOORS. WITH
BALL BEARING.



CC 9009

PLUS ÇELİK KAPI GÖMME EMNİYET KİLİDİ.
SAFETY MORTISE LOCK FOR STEEL DOORS.



ALARMLI ÇELİK KAPI KİLİDİ

Alarmed Steel Gate Lock

HOK
KİLİTLERİ

CS 9900



105 dB ALARM SESİ YOĞUNLUĞU
105* dB ALARMS SOUND INTENSITY

ÇİFT KORUMA



Olağandışı darbelere ve kapı açılmalarına karşı manyetik korumave darbe algılayıcı

DOBLE PROTECTION

Magnetic protection and impact sensör against abnormal impacts and door openings

KOLAY PİL DEĞİŞİMİ



2 x AA pil ile 2 yıla kadar bekleme süresi

EASILY CHANGEABLE BATTERY

Stand-by up to 2 years with 2 x AA alkaline battery

KOLAY MONTAJ



Mevcut Çelik kapı kilidi yerine uygulanabilir.

EASY INTTALLATION

Applicable in place of existing steel gate lock



ÇELİK KAPI KİLİTLERİ

Steel Door Locks

HOK
KİLİTLERİ

CE 9201

CHAMPION KANCALI ÇELİK KAPI GÖMME KİLİDİ.
RULMANLI

MORTISE LOCK WITH REVERSE CLAWS FOR STEEL DOORS.
WITH BALL BEARING.



CE 9209

CHAMPION KANCALI ÇELİK KAPI GÖMME EMNİYET KİLİDİ.
RULMANLI

SAFATY MORTISE LOCK WITH REVERSE CLAWS.
FOR STEEL DOORS.

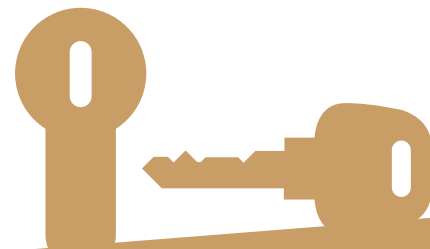

YARI MERKEZİ VE MERKEZİ KİLİT

Semi Center and Central Lock

HOK
KİLİTLERİ

YARI MERKEZİ

MULTİSİSTEM YARI MERKEZİ SİSTEM ÇELİK KAPI KİLİDİ.
RULMANLI

MULTI-POINT SEMI-CENTRAL LOCKING SYST
WITH BALL BEARING.



KLASİK MERKEZİ

MULTİSİSTEM MERKEZİ ÇELİK KAPI KİLİDİ.
RULMANLI.

MULTI-POINT CENTRAL LOCKING
SYSTEM FOR STEEL DOORS.
WITH BALL BEARING.



İÇ ODA VE SİLİNDİRLİ KİLİTLER

Cylinder and Interior Locks

HOK
KİLİTLERİ

ET 40

NORMAL GÖMME WC KİLİDİ

ER 40

EKSTRA GÖMME ODA KİLİDİ



SR 40

SİLİNDİRLİ GÖMME KİLİT
GENİŞ TİP



SR 45 M

SİLİNDİRLİ RULMALI ODA KİLİDİ

SR 45

SİLİNDİRLİ GÖMME KİLİT



189 3 FM

PRAZİS GÖMME
EMNİYET KİLİDİ

SİLİNDİRLER

Cylinders

HOK
KİLİTLERİ

BİLYALI YUVARLAK TOPUZLU

BİLYALI SİLİNDİR



YARIM TİP TOPUZLU SİLİNDİR



TOPUZLU STANDART SİLİNDİR



YARIM TİP STANDART SİLİNDİR



STANDART SİLİNDİR



DIŞTAN TAKMA TİRAJLI KİLİTLER

Surface Mount Rim Locks

HOK
KİLİTLERİ

MT 14 B

SİLİNDİRLİ, TRAJLI (SIVAMA BİLYALI)

MT 14

SİLİNDİRLİ, TRAJLI (SIVAMA)



ST 14

STANDART SİLİNDİRLİ, TRAJLI



ST 14 B

SİLİNDİRLİ, TRAJLI (BİLYALI)



AKILLI KİLİT - ŞARJ EDİLEBİLİR LİTYUM PİLLİ

Smart Lock

utopic R

Dünyanın
En Küçüğü



GENEL ÖZELLİKLER

- Çap: 50 mm / uzunluk: 60 mm
- Silindir ile çalışan her kapıya uygulanabilme
- Kilidin anahtarla kullanımına engel olmayan akıllı tasarım
- Şarj edilebilir Lithium pillerle tek şarjda 8* ay bekleme ya da 3 turlu kilitte 2.800* operasyon. RF alıcı ile bluetooth birlikte kullanılıyorsa, bekleme süresi yarıya iner.
- 100 tane parmak izini tanıyabilen geniş hafıza
- Kablosuz haberleşme altyapısı sayesinde ev otomasyon sistemleri ile tam entegrasyon
- Yüksek güvenli kapasitif parmak izi okuma teknolojisi ve 500 dpi sensör hassasiyeti
- İç tarafı teleskobik olarak 12mm uzayabilen silindir, coreless motor opsiyonu, microUSB şarj girişi.

UYUMLU AKSESUARLAR ve KONTROLCÜLER



Kablosuz Parmak İzi Okuyucu



Kablosuz Dokunmatik Tuştakımı



Kablosuz Otomasyon Arayüzü



Mobil Uygulama



Uzaktan Kumanda



Kablosuz Otomatik Kilitleme Modülü

utopic R



AKILLI KİLİT - KALEM PİLLİ

Smart Lock

utopic 2

Bluetooth
Seçeneğiyle



GENEL ÖZELLİKLER

- Çap: 60 mm / Uzunluk: 72 mm (silindir hariç)
- Silindir ile çalışan neredeyse her kapıya uygulanabilme
- Kullanım kolaylığı sağlayan dokunmatik butonlar ve dijital göstere
- Kilidin anahtarla kullanımına engel olmayan akıllı tasarım
- 5 x AA alkalın pille 3* yıl bekleme ya da 3 turlu kilitte 8.000* açma veya kapama RF alıcı ile bluetooth birlikte kullanılıyorsa, bekleme süresi yarıya iner
- 100 tane parmak izini tanıyabilen geniş hafıza
- Kablosuz haberleşme altyapısı sayesinde ev otomasyon sistemleri ile tam entegrasyon
- Yüksek güvenli kapasitif parmak izi okuma teknolojisi ve 500 dpi sensör hassasiyeti
- Satına kaplamalı zamak parçalar

UYUMLU AKSESUARLAR ve KONTROLCÜLER



Kablosuz Parmak İzi Okuyucu



Kablosuz Dokunmatik Tuştakımı



Kablosuz Otomasyon Arayüzü



Mobil Uygulama (Bluetooth Uyumlu Kontrolcüler Aracılığıyla)



Uzaktan Kumanda



Kablosuz Otomatik Kilitleme Modülü

utopic 2



KLASİK - ELEKTRİKLİ, ALKALİN VEYA LİTYUM PİLLİ

Classic

PIKS Classic

GENEL ÖZELLİKLER



- Kontrol Kutusu: 250 x 40 x 84 mm
- Parmak izi okuyucu için açılacak yuvanın çapı: 60 MM
- 1000+ parmak izi hafızası
- Zamak, ABS malzeme
- 4 x C tip alkalin pil
- 4 yıl bekleme ya da 3 turlu kilitte 12.000* operasyon.
- Ürün altparçaları arasında kablolu bağlantı, 434 Mhz alıcı
- Suprema Optik (500 dpi) parmak izi sensörü
- 69 mm'den daha kalın silindirli kilide sahip kapıların tümü ile uyumluluk
- Ankastre montaj
- Led gösterge, kolay kullanım

UYUMLU AKSESUARLAR ve KONTROLCÜLER



Kablosuz Dokunmatik Tuştakımı (Bluetooth)

Kablosuz Otomatik Kilitleme Modülü

Kablosuz Otomasyon Arayüzü

Mobil Uygulama (Bluetooth Uyumlu Kontrolcüler Aracılığıyla)

Uzaktan Kumanda



ALARMLI KAPI KİLİDİ

Alarm Door Lock

DAK

GENEL ÖZELLİKLER



- Bütün çelik kapılar ile uyumluluk (çap: 50 mm / uzunluk: 60 mm)
- 3 tur kilitlendiğinde devreye giren alarm
- Hassasiyeti ayarlanabilir darbe sensörü
- Kapının açıldığını algılayan açılma sensörü
- 2 x AA kalem pille 2,5* yıl bekleme ya da 3 tur 10.000* operasyon
- Pillerin zayıflaması durumunda pil bitme uyarısı
- Kablosuz haberleşme altyapısı sayesinde ev otomasyon sistemleri ile tam entegrasyon
- 105 dB yüksekliğinde alarm sesi
- Kolay montaj



UYUMLU AKSESUARLAR ve KONTROLCÜLER



Kablosuz Parmak İzi Okuyucu

Kablosuz Dokunmatik Tuştakımı

Kablosuz Otomasyon Arayüzü

Mobil Uygulama (Bluetooth Uyumlu Kontrolcüler Aracılığıyla)

Uzaktan Kumanda

Kablosuz Otomatik Kilitleme Modülü

DAK Alarmli Kapi Kilidi



KONTROLCÜLER

ANKASTRE KABLOSUZ PARMAK İZİ OKUYUCU



ÖLÇÜLER (Silindirik)		100 x 28 x 28 mm
ÖLÇÜLER (Dikdörtgen)		100 x 28 x 23 mm
MALZEME		Zamak, P/C
PARMAK İZİ SENSÖRÜ		FPC 1011
PARMAK İZİ HAFIZASI		100 kayıt
GÜÇ		2x AAA size 1,5 V alkalin pil veya lityum batarya
HABERLEŞME		Yüksek güvenli RF haberleşme
DİĞER		Dokunmatik tuşlar, oled gösterge
UYUMLU CİHAZLAR		Tüm DESi ürünleri



30mm çaplı silindirik çekme kolu için



30x30mm kesitli dikdörtgen çekme kolu için

ÇEKME KOLUNA TAKILAN PARMAK İZİ OKUYUCU

Ankastre olarak çekme koluna takılan bu cihaz ile birlikte parmağınız anahtarınız olacak. Ayrıca Bluetooth uyumlu versiyonu, standart DESi ürünlerini ve cep telefonunuzla kullanmanızı da sağlar.

KAPI VE PENCERE ALARMI

Door and Window Alarm



STEELY SB R
KUMANDALI
KABLOSUZ
KAPI ALARMI
(DAR PROFİL)

GENEL ÖZELLİKLER

- 188,5 x 22,5 x 49 mm
- ABS Malzeme
- 2 x AAA alkalin pil (2 yıla kadar bekleme süresi)
- Çift Koruma; Manyetik kontak ve darbe sensörü
- 105 dB* ses alarm sesi
- Uzaktan kumandalı kontrol

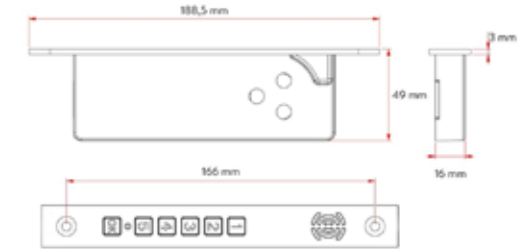

STEELY SB K
TUŞ TAKIMLI
KABLOSUZ
KAPI ALARMI
(DAR PROFİL)

GENEL ÖZELLİKLER

- 188,5 x 22,5 x 49 mm
- ABS Malzeme
- 2 x AAA alkalin pil (2 yıla kadar bekleme süresi)
- Çift Koruma; Manyetik kontak ve darbe sensörü
- 105 dB* ses alarm sesi
- Uzaktan kumandalı kontrol

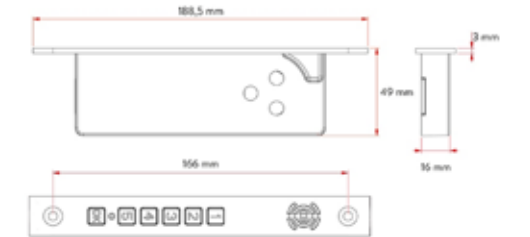

PARMAK İZİ OKUYUCU ÜNİTESİ

X10 Fingerprint Reader Unit

KD 049/30-100

X10 PARMAK İZİ OKUYUCU ÜNİTESİ
X10 FINGERPRINT READER UNIT

PARMAK İZİ
OKUYUCU
X10



200 PARMAK İZİ
HAFIZA KAPASİTESİ
200 FINGERPRINT
MEMORY CAPACITY

OLED-0,96"
DOKUNMATİK KULLANIM
OLED-0,96"
TOUCH OPERATION TYPE

ŞARJ EDİLEBİLİR
LİTYUM PİL
RECHARGEABLE
LITHIUM BATTERY

KEYLOCK GÜVENLİK
KOD TEKNOLOJİSİ
KEYLOCK SECURITY
CODE TECHNOLOGY

X10 AKILLI KİLİT
SİSTEMİ İLE UYUMLU
WORK WITH X10 SMART
LOCK SYSTEM



X10 AKILLI KİLİT SİSTEMİ

X10 Smartlock System

KD 049/10-200

ANAHTAR KELİME
"KUMANDA"

KEYWORD IS
"REMOTE CONTROL"



UZAKTAN ERİŞİM
REMOTE ACCESS

AKILLI ANAHTAR
SMART KEY



AKILLI
KİLİT
SİSTEMİ

X10



ASMA KİLİTLER

Padlocks

GRİ DÖKÜM - 63 MM
IRON

KDO 01/10-160



GRİ DÖKÜM - 20 MM
IRON

KDO 01/10-120



GRİ DÖKÜM - 25 MM
IRON

KDO 01/10-125



GRİ DÖKÜM - 32 MM
IRON

KDO 01/10-130



GRİ DÖKÜM - 38 MM
IRON

KDO 01/10-140



GRİ DÖKÜM - 50 MM
IRON

KDO 01/10-150



ASMA KİLİTLER

Padlocks

SARI - 63 MM
BRASS

KDO 01/10-260



SARI - 20 MM
BRASS

KDO 01/10-220



SARI - 25 MM
BRASS

KDO 01/10-225



SARI - 32 MM
BRASS

KDO 01/10-230



SARI - 38 MM
BRASS

KDO 01/10-240



SARI - 50 MM
BRASS

KDO 01/10-250

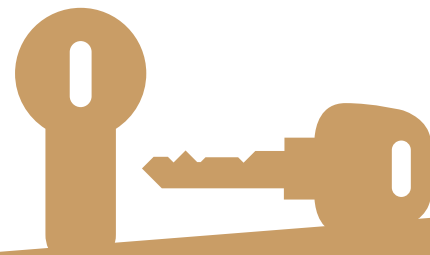

ANKASTRE DUVAR KASALARI

Household Safes

ANKASTRE DUVAR KASALARI
HOUSEHOLD SAFES

KKLAP-TOP3001

Kasaların iç yüzeyleri kadifeyle kaplıdır.
Oda duvarlarına sığabilecek ölçülerde,
emniyetli,
pratik ve dikkat çekmeyecek özelliktedir.



ANKASTRE DUVAR KASALARI
HOUSEHOLD SAFES

KKLAP-TOP4001

Kasaların iç yüzeyleri kadifeyle kaplıdır.
Oda duvarlarına sığabilecek ölçülerde,
emniyetli,
pratik ve dikkat çekmeyecek özelliktedir.



ANKASTRE DUVAR KASALARI
HOUSEHOLD SAFES

KKLAP-ECO4001

Kasaların iç yüzeyleri kadifeyle kaplıdır.
Oda duvarlarına sığabilecek ölçülerde,
emniyetli,
pratik ve dikkat çekmeyecek özelliktedir.



BÜRO EV TİPİ KASALAR

Office Household Safes

ELEKTRONİK ŞİFRELE EV TİPİ KASA
OFFICE-HOUSEHOLD SAFES

KKECO-2500

Büro ve evlerde para, mücevher ve değerlerin korunması için, küçük ölçülerde imal edilmektedir. Dekorasyonun bir parçası olacak biçimde, arzu edilen renklerde fakat kolayca taşınamayacak kadar ağır olarak yapılmışlardır. Kasaların iç yüzeyleri kadifeyle kaplıdır.



ELEKTRONİK ŞİFRELE EV TİPİ KASA
HOUSEHOLD SAFES

KK-300

Ev tipi kasalarımızın iç yüzeyleri kadife ile kaplı olup, evinizde farklı mekanlarda kullanıma uygundur.



EV TİPİ KASA
HOUSEHOLD SAFES

KK-300

Ev tipi kasalarımızın iç yüzeyleri kadife ile kaplı olup, evinizde farklı mekanlarda kullanıma uygundur.



ELEKTRONİK ŞİFRELE BÜRO EV TİPİ KASA
OFFICE-HOUSEHOLD SAFES

KK-400

Büro ve evlerde para, mücevher ve değerlerin korunması için, küçük ölçülerde imal edilmektedir. Dekorasyonun bir parçası olacak biçimde, arzu edilen renklerde fakat kolayca taşınamayacak kadar ağır olarak yapılmışlardır. Kasaların iç yüzeyleri kadifeyle kaplıdır.



ELEKTRONİK ŞİFRELE

KK-400

Ev tipi kasalarımızın iç yüzeyleri kadife ile kaplı olup, evinizde farklı mekanlarda kullanıma uygundur.



DEKORATİF KASA
DECORATIVE SAFES

KK-400 D

Kasalarınıza dekoratif boya veya mobilyalarınızla uyumlu standart ahşap kaplama seçenekleri uygulanabilir. Ahşap kaplama seçenekleri, kasa ölçülerini 1'er cm artırmaktadır.



DEKORATİF KASA
DECORATIVE SAFES

KK-400

Kasalarınıza dekoratif boya veya mobilyalarınızla uyumlu standart ahşap kaplama seçenekleri uygulanabilir. Ahşap kaplama seçenekleri, kasa ölçülerini 1'er cm artırmaktadır.

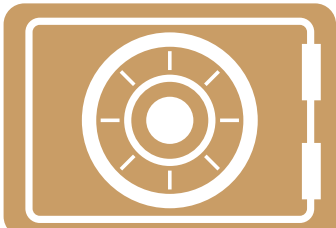

BÜYÜK KASALAR

Large Safes

RENKLİ KASALAR COLORFUL SAFES

KK 190

Renkli kasalarımızın iç yüzeylerinde tabanda özel kaplama mevcuttur, evinizde farklı mekanlarda kullanıma uygundur.



RENKLİ KASALAR COLORFUL SAFES

KK 200

Renkli kasalarımızın iç yüzeylerinde tabanda özel kaplama mevcuttur, evinizde farklı mekanlarda kullanıma uygundur.



ANKASTRE DUVAR KASALARI HOUSEHOLD SAFES

KK-450

Kasaların iç yüzeyleri kadifelye kaplıdır. Oda duvarlarına sığabilecek ölçülerde, emniyetli, pratik ve dikkat çekmeyecek özelliktedir.



DİJİTAL MOTORLU

KD-60-30-101



TİCARİ KASALAR

Business Safes

ÇELİK KASA - TİCARİ KASALAR

Bütün kasalarımıza istek üzerine elektronik veya mekanik şifre takılabilir. Orta ve büyük boy kasaların içinde ayrıca yer alan özel güvenlik bölümü çok önemli değerlerinize ekstra güvenlik sağlar. Kasa içindeki tırnak sistemiyle, raf aralıkları istenilen ölçüde ayarlanabilir. Toplam yükseklik hesaplanırken, baza yüksekliği dış yüksekliğe ilave edilmiştir.

Kale Çelik Kasa detay görünümü

- 1- Kale Çelik Kasa modelleri, kademeli gövdeleriyle ateşe karşı güvenli hale getirilmiştir.
- 2-Büyük tip kasalara, ihtiyaca göre ilave şifre eklenebilir.
- 3-Kale Çelik Kasa modellerinin kapıları 4 tarafından özel çelik pimlerle kilitlemektedir.
- 4-Kol, anahtar ve şifre sisteminden oluşan değişik kombinasyonlu kilitleme sistemleri, değişik ihtiyaçları karşılayan Kale Çelik Kasa üretim hattında uygulanmaktadır.

KK-550



KK-600



KK-800



KK-1000



KK-1200



YANGINA DAYANIMI DESTEKLENDİRİLMİŞ EVRAK KASASI

Kasa içindeki tırnak sistemiyle, raf aralıkları istenilen ölçüde ayarlanabilir. Orta ve büyük boy kasaların içinde ayrıca yer alan özel güvenlik bölümü çok önemli değerlerinize ekstra güvenlik sağlar. Kale Çelik Kasa modelleri kademeli gövdeleriyle ateşe ve dumana karşı güvenli hale getirilmiştir.

KK-1500



KK-1750



KK-1758



KK-2000

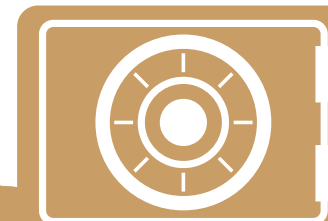

KALE KAPI HİDROLİKLERİ - STANDART

Kale Door Closers - Standard

KDO 02/50-330

GÜMÜŞ - STANDART
SILVER - STANDARD



KDO 02/50-440

GÜMÜŞ STANDART
SILVER STANDARD



KDO 02/50-550

BRONZ STANDART
BRONZE STANDARD



KD002/70-330

GÖMME RAYLI PASLANMAZ HİDROLİK
STAINLESS RAIL STAINLESS HYDRAULIC



KD002/70-440

GÖMME RAYLI PASLANMAZ HİDROLİK
STAINLESS RAIL STAINLESS HYDRAULIC



KD002/70-550

GÖMME RAYLI PASLANMAZ HİDROLİK
STAINLESS RAIL STAINLESS HYDRAULIC



KD002/40-330

PASLANMAZ RAYLI HİDROLİK
RAIL STAINLESS HYDRAULIC



KD002/40-440

PASLANMAZ RAYLI HİDROLİK
RAIL STAINLESS HYDRAULIC



KDO 02/80-220

KDO 02/80-330

KDO 02/80-440

KDO 02/80-550

GÜMÜŞ STANDART
SILVER STANDARD



ELEKTRİKLİ KARŞILIKLARI

Electrical Door Openers

KDO 12/20-124

MULTİ TİPİ
MULTI TYPE



KDO 12/20-125

MONOBLOK TİPİ
MONOBLOCK TYPE



ŞİFRELİ KİLİTLER

Keypad Locks

KD050/50-110



PARMAK İZLİ KALE ELEKTRONİK KİLİT HASSAS BİYOMETRİK OKUYUCUSU SAYESİNDE HIZLI OKUNUYOR VE KOLAYCA AÇILIYOR. İSTEYEN KULLANICILAR PARMAK İZİ YERINE ŞİFRE KULLANIMINI DA TERCİH EDEBİLİR.

FINGERPRINT KALE ELECTRONIC LOCK CAN BE READ QUICKLY AND OPENED EASILY THANKS TO ITS SENSITIVE BIOMETRIC READER. USERS CAN ALSO CHOOSE TO USE THE PASSWORD INSTEAD OF THE FINGERPRINT.



KARTLI KİLİTLER

Card Operated Locks

KD040/87-260

OFİSİNİZ SİZİN
KONTROLÜNÜZDE
YOUR OFFICE IS
UNDER YOUR CONTROL

LÜKS SERİ / OFİS TİPİ - SATEN
LUXURY SERIES / OFFICE TYPE - SATIN



GİZLİ BAREL
HIDDEN CYLINDER



ELEKTRONİK
KİLİTLEME BUTONU
ELECTRONIC
LOCKING BUTTON



ŞİFRELİ KİLİTLER

Keypad Locks

KD040/87-244

GÜVENLİĞİNİZ
AKLINIZDA KALSIN
KEEP YOUR
SAFETY IN MIND!

LÜKS SERİ / OFİS TİPİ - SATEN
LUXURY SERIES / OFFICE TYPE - SATIN



GİZLİ BAREL
HIDDEN CYLINDER

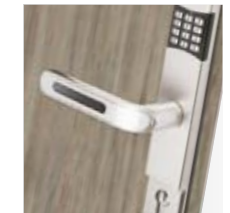

Sabit/Geçici Şifre Sistemi
Permanent/OTC System

ELEKTRONİK
KİLİTLEME BUTONU
ELECTRONIC
LOCKING BUTTON



MOTORLU OTOMAT - X5 OTOMAT

Motorized Vending Machine

KD 050/30-100

X5 OTOMAT



KD050/30-400

KALE MOTORLU OTOMAT



TOPUZ KİLİTLER

Knob Locks

KD 040-30-320

PASLANMAZ VE PİRİNÇ MALZEMEDEN ÜRETİLEN KALE TOPUZLU KİLİTLER. GEREK ODA, GEREK BANYO-WC, GEREKSE GİRİŞ KAPILARINDA KULLANILABİLECEK SEÇENEKLERİ İLE FONKSİYONELLİK VE DAYANIKLILIK SUNUYOR. 5 SEVİYEYE KADAR MASTERLAMAYA UYGUNDUR.

MANUFACTURED FROM STAINLESS AND BRASS MATERIALS, KALE KNOB LOCKS OFFER FUNCTIONALITY AND DURABILITY WITH OPTIONS THAT CAN BE USED IN ROOMS, BATHROOMS-WC AND ENTRANCE DOORS. SUITABLE FOR MASTERING UP TO 5 LEVELS.



KD 040-36-300



KD 040-35-300



GEÇİŞ KONTROL ÜNİTELERİ

Access Control Units Devices

KD050/10-900



KARTLI GEÇİŞ KONTROL ÜNİTESİ
ACCESS CONTROL UNITS CARD



ŞİFRELİ GEÇİŞ KONTROL ÜNİTESİ
ACCESS CONTROL UNITS KEYPAD



ŞİFRELİ GEÇİŞ KONTROL ÜNİTESİ
ACCESS CONTROL UNITS KEYPAD

ELEKTRONİK KABİN KİLİTLERİ

Electronic Cabinet Locks

Tüm ahşap ve saç kabin, dolap ve çekmecelere uygulanabilen Kale Kabin Kilitleleri, istenildiğinde şifreyle, bileklikli ID anahtar veya mifare yazılımlı kartlarla açılabilir. Spa merkezlerinde, öğrenci dolaplarında, spor ve sağlık merkezlerinde kolay kullanımlı, yönetilebilir ve kontrol edilebilir güvenlik sağlıyor.



KD-050/45-115
Gümüş



KD-050/45-106
Gümüş



KD-050/45-110
Gümüş



KD-050/45-116
Gümüş

YENİ



KD-050/45-211
Kırmızı



KD-050/45-212
Mavi



OUR OWN PRODUCTIONS

**KENDİ
ÜRETİMİMİZ**



BALCO

ALÜMİNYUM

KENDİ ÜRETİMİMİZ

Our Production



İSTENİLEN ÖLÇÜDE ÜRETİM YAPILABİLİR
PRODUCTION CAN BE MADE TO THE DESIRED SIZE

2502

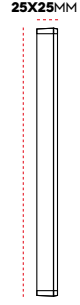

RENKLER

Colours

- 2501 SATEN Saten
- 2502 SİYAH Black
- 2503 SARI Yellow

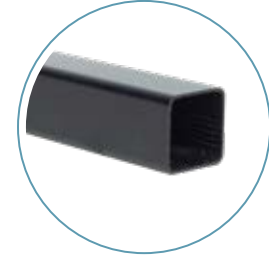

3001

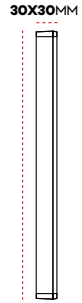

RENKLER

Colours

- 3001 SATEN Saten
- 3002 SİYAH Black
- 3003 SARI Yellow

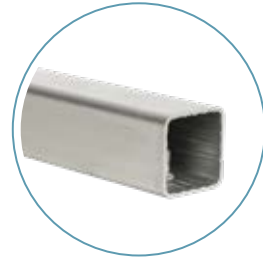

3012

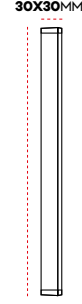

RENKLER

Colours

- 3011 SATEN Saten
- 3012 SİYAH Black
- 3014 SARI Yellow

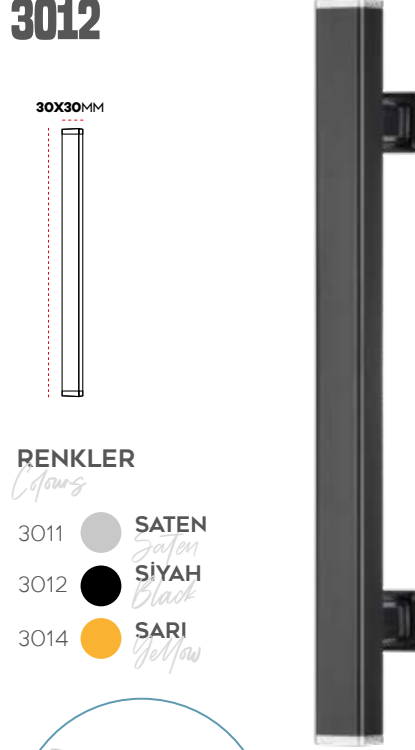

KENDİ ÜRETİMİMİZ

Our Production



İSTENİLEN ÖLÇÜDE ÜRETİM YAPILABİLİR
PRODUCTION CAN BE MADE TO THE DESIRED SIZE

3040

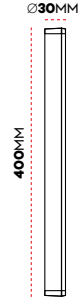

RENKLER

Colours

- 3040 SATEN Saten
- 3041 SİYAH Black
- 3042 SARI Yellow

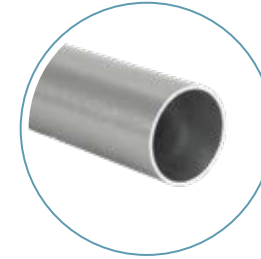

2540-S

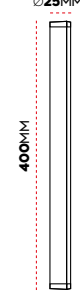

RENKLER

Colours

- 2540-S SATEN Saten
- 2541-S SİYAH Black
- 2542-S SARI Yellow



2540

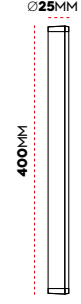

RENKLER

Colours

- 2540 SATEN Saten
- 2541 SİYAH Black
- 2542 SARI Yellow



KENDİ ÜRETİMİMİZ

Our Production



İSTENİLEN ÖLÇÜDE ÜRETİM YAPILABİLİR
PRODUCTION CAN BE MADE TO THE DESIRED SIZE

9001-S

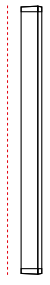

RENKLER

Colors

- 9001-S SATEN Saten
- 9002-S SİYAH Black
- 9003-S SARI Yellow



9001



RENKLER

Colors

- 9001 SATEN Saten
- 9002 SİYAH Black
- 9003 SARI Yellow

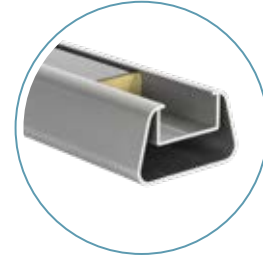

9011



RENKLER

Colors

- 9011 SATEN Saten
- 9012 SİYAH Black
- 9013 SARI Yellow



KENDİ ÜRETİMİMİZ

Our Production



İSTENİLEN ÖLÇÜDE ÜRETİM YAPILABİLİR
PRODUCTION CAN BE MADE TO THE DESIRED SIZE

5021

46X20MM



RENKLER

Colors

- 5021 SATEN Saten
- 5022 SİYAH Black
- 5023 SARI Yellow

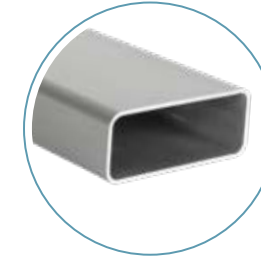

5021-S

50X20MM



RENKLER

Colors

- 5021-S SATEN Saten
- 5022-S SİYAH Black
- 5023-S SARI Yellow

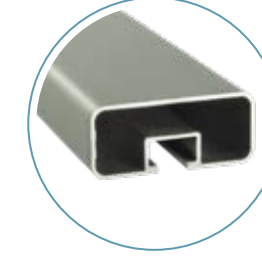

5001

50X10MM



RENKLER

Colors

- 5001 SATEN Saten
- 5002 SİYAH Black
- 5003 SARI Yellow

KENDİ ÜRETİMİMİZ

Our Production



İSTENİLEN ÖLÇÜDE ÜRETİM YAPILABİLİR
PRODUCTION CAN BE MADE TO THE DESIRED SIZE

7002



RENKLER

Colors

- 7001 SATEN Saten
- 7002 SİYAH Black
- 7003 SARI Yellow



6001



RENKLER

Colors

- 6001 SATEN Saten
- 6002 SİYAH Black
- 6003 SARI Yellow
- 6004 KROM Chrom



6014



RENKLER

Colors

- 6011 SATEN Saten
- 6012 SİYAH Black
- 6013 SARI Yellow
- 6014 KROM Chrom



KENDİ ÜRETİMİMİZ

Our Production



İSTENİLEN ÖLÇÜDE ÜRETİM YAPILABİLİR
PRODUCTION CAN BE MADE TO THE DESIRED SIZE

8001

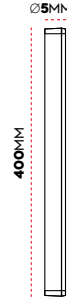

RENKLER

Colors

- 8001 SATEN Saten
- 8002 SİYAH Black
- 8003 SARI Yellow



8012



RENKLER

Colors

- 8011 SATEN Saten
- 8012 SİYAH Black
- 8013 SARI Yellow



30X120-4 AYAK

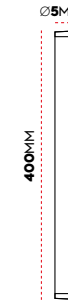

RENKLER

Colors

- 30X120-4-1 SATEN Saten
- 30X120-4-2 SİYAH Black
- 30X120-4-3 SARI Yellow



KENDİ ÜRETİMİMİZ

Our Production



İSTENİLEN ÖLÇÜDE ÜRETİM YAPILABİLİR
PRODUCTION CAN BE MADE TO THE DESIRED SIZE

8 KANALLI LAMA



RENKLER

Colors

- 8K-1 SATEN *Satin*
- 8K-2 SİYAH *Black*
- 8K-3 SARI *Yellow*



2 KANALLI LAMA



RENKLER

Colors

- 2K-1 SATEN *Satin*
- 2K-2 SİYAH *Black*
- 2K-3 SARI *Yellow*



LAMA 101

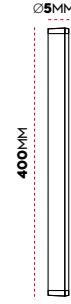

RENKLER

Colors

- 101 SATEN *Satin*
- 102 SİYAH *Black*
- 103 SARI *Yellow*



KENDİ ÜRETİMİMİZ

Our Production



İSTENİLEN ÖLÇÜDE ÜRETİM YAPILABİLİR
PRODUCTION CAN BE MADE TO THE DESIRED SIZE

LZR-101

RENKLER

Colors

- 101 SATEN *Satin*
- 102 SİYAH *Black*
- 103 SARI *Yellow*

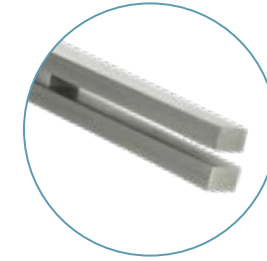

LZR-301

RENKLER

Colors

- 301 SATEN *Satin*
- 302 SİYAH *Black*
- 303 SARI *Yellow*



LZR-201

RENKLER

Colors

- 201 SATEN *Satin*
- 202 SİYAH *Black*
- 203 SARI *Yellow*



KENDİ ÜRETİMİMİZ

Our Production



İSTENİLEN ÖLÇÜDE ÜRETİM YAPILABİLİR
PRODUCTION CAN BE MADE TO THE DESIRED SIZE

LZR-401

RENKLER

- Colors*
- 401 SATEN *Satin*
 - 402 SİYAH *Black*
 - 403 SARI *Yellow*



LZR-501

RENKLER

- Colors*
- 501 SATEN *Satin*
 - 502 SİYAH *Black*
 - 503 SARI *Yellow*

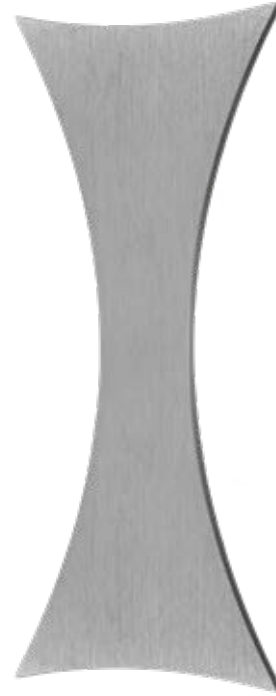

LZR-601

RENKLER

- Colors*
- 601 SATEN *Satin*
 - 602 SİYAH *Black*
 - 603 SARI *Yellow*



KENDİ ÜRETİMİMİZ

Our Production



LZR-701

RENKLER

- Colors*
- 701 SATEN *Satin*
 - 702 SİYAH *Black*
 - 703 SARI *Yellow*



LZR-901

RENKLER

- Colors*
- 901 SATEN *Satin*
 - 902 SİYAH *Black*
 - 903 SARI *Yellow*



LZR-801

RENKLER

- Colors*
- 801 SATEN *Satin*
 - 802 SİYAH *Black*
 - 803 SARI *Yellow*



LZR-912

RENKLER

- Colors*
- 911 SATEN *Satin*
 - 912 SİYAH *Black*
 - 913 SARI *Yellow*



AHŞAP-11

RENKLER

- Colors*
- 11 SATEN *Satin*
 - 12 SİYAH *Black*
 - 13 SARI *Yellow*



AHŞAP-21

RENKLER

- Colors*
- 21 SATEN *Satin*
 - 22 SİYAH *Black*
 - 23 SARI *Yellow*



AHŞAP-51

RENKLER

- Colors*
- 51 SATEN *Satin*
 - 52 SİYAH *Black*
 - 53 SARI *Yellow*



AHŞAP-31

RENKLER

- Colors*
- 31 SATEN *Satin*
 - 32 SİYAH *Black*
 - 33 SARI *Yellow*



AHŞAP-42

RENKLER

- Colors*
- 41 SATEN *Satin*
 - 42 SİYAH *Black*
 - 43 SARI *Yellow*



H ÇİTA

RENKLER

- Colors*
- H-1 SATEN *Satin*
 - H-2 SİYAH *Black*
 - H-3 SARI *Yellow*

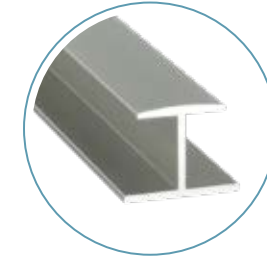

30X30 KÖŞEBENT

RENKLER

- Colors*
- 30X30-1 SATEN *Satin*
 - 30X30-2 SİYAH *Black*
 - 30X30-3 SARI *Yellow*

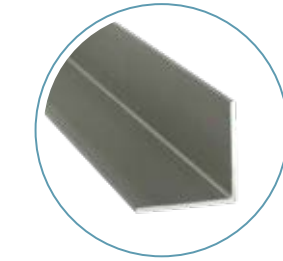

120X20 TEKMELİK

RENKLER

- Colors*
- 120X20-1 SATEN *Satin*
 - 120X20-2 SİYAH *Black*
 - 120X20-3 SARI *Yellow*

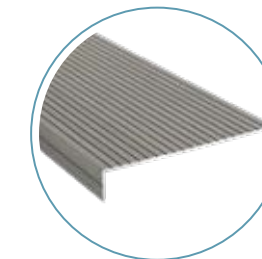

DÜZ

- RENKLER
Colors
- SİYAH
Black
 - SATEN
Satin
 - SARI
Yellow

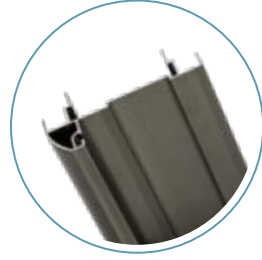

ÇİZGİLİ

- RENKLER
Colors
- SİYAH
Black
 - SATEN
Satin
 - SARI
Yellow

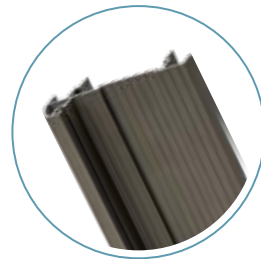

KANAT T PARÇASI

- RENKLER
Colors
- SİYAH
Black
 - SATEN
Satin
 - SARI
Yellow

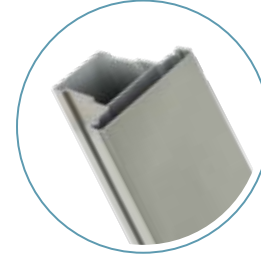

ALÜMİNYUM FERFORJE

- RENKLER
Colors
- SİYAH
Black
 - SATEN
Satin
 - SARI
Yellow

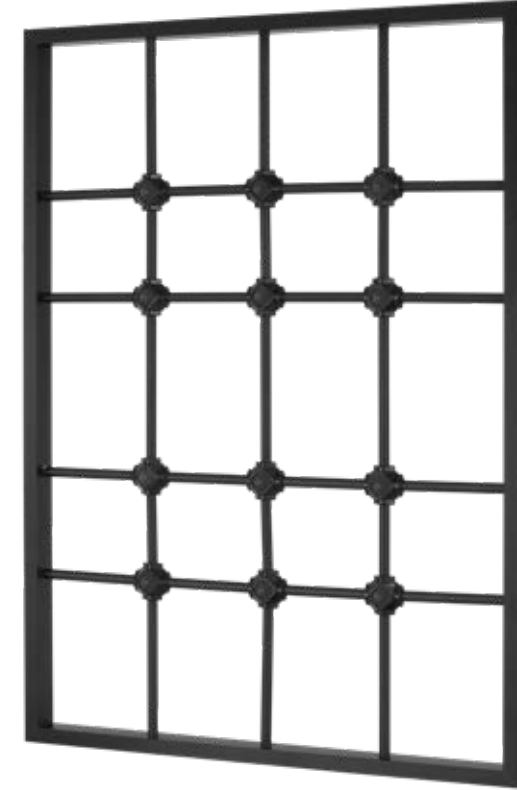

ALÜMİNYUM FERFORJE

- RENKLER
Colors
- SİYAH
Black
 - SATEN
Satin
 - SARI
Yellow

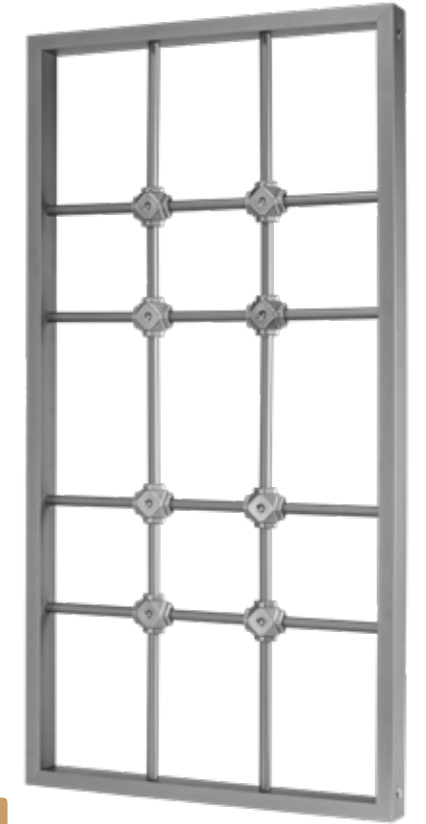



KAPI
KOLLARI
DOOR
HANDLES



PRİNÇ ROZETLİ KOLLAR

Brass Rosette Handles

BERİL



ÇINAR 2



HAVZA



VELETA



ZAMAK KOLLAR

Zinc Alloy Handles

ARAS



ATLAS



ECE



DORUK



GÜL

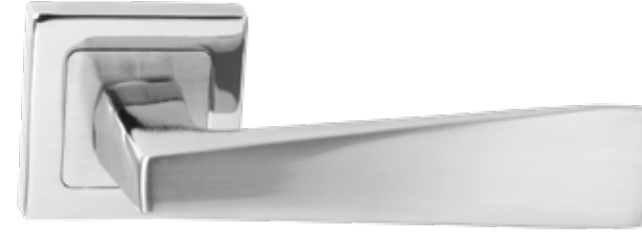

ERCIYES



ZAMAK KOLLAR

Zinc Alloy Handles

HİSAR



KUMRU



LİVA



PIRAMİT



TUNA



HAMİSİ



YÜSRA



PASLANMAZ ROZETLİ KOLLAR

Stainless Rosette Handles

1001



MARS



1003



BALCO 1004

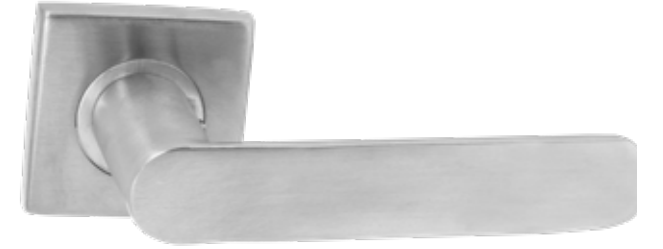

ALÜMİNYUM ROZETLİ KOLLAR

Aluminum Rosed Handles

ARAS



ARZA



ASPENDOS



ATLAS



BALİNA



BASTON



FROZEN



KARAHANLI



HAMŞİ



BEYKOZ



BEYLERBEYİ



BRAVO



HİSAR



NAKIŞLI SATEN



NAKIŞLI SİYAH



KAVACIK



KOBRA



KONAK



ES KOL



ESAT



EUROPA



KANLICA



PİRAMİT



ALÜMİNYUM ROZETLİ KOLLAR

Aluminium Rosed Handles

RİVA



SÜLÜN



GAMZE



ROZET ALTI ODA



ROZET ALTI YALE



ROZET ALTI WC



SİYAH ROZETLİ KOLLAR

Black Rosed Arms

1003 BALCO



1004 BALCO



ARAS



EFES



PİRAMİT



SİMGE



ZÜMRÜT



ALÜMİNYUM ROZETLİ KOLLAR

Aluminum Rosed Handles

ARAS 1



ARAS 2



BALİNA



BEYKOZ



BEYKOZ



HAMSi 2



HİSAR



HİSAR 2



KALAMIŞ



KANLICA 1



BEYLERBEYİ



BRAVO



ÇAĞLA



DALGA



DİPLOMAT



KANLICA 2



KARAHANLI 1



KARAHANLI 2



KARTAL



KAVACIK 1



ELMAS



ES KOL



EUROPA



GÜL



HAMSi 1



KAVACIK 2



KOBRA



KONAK 1



KONAK 2



KONAK 3



ALÜMİNYUM ROZETLİ KOLLAR

Aluminum Rosed Handles

ALÜMİNYUM ROZETLİ KOLLAR

Aluminum Rosed Handles

KÖSEM



KUĞU 1



KUĞU 2



KUMRU



MENEKŞE



ORKİDE



PİRAMİT



TOMBUL



TOPKAPI



TUNA



TURNA



VEGA



YALI



YUNUS



ZAMBAK



PİRİNÇ ÇEKME KOLLAR

Brass Pull Handles

**AHŞAPLI
4059**



BORA



BÜYÜK SÖĞÜT



HAVZA 2
İki boğumlu



HAVZA 3
Üç boğumlu



LAMA



SÖĞÜT



VALETTA



ZİYNET



ZAMAK ÇEKME KOLLAR

Zamak Pull Handles

EVEREST ZAMAK



RENKLER
Colors

● SATEN *Satin* ● SARI *Yellow*

PASLANMAZ ÇEKME KOLLAR

Stainless Pull Handles

25X40



30X40



435



440



ALT ROZETLİ



AMANOS



AMASRA



ASOS



PASLANMAZ ÇEKME KOLLAR

Stainless Pull Handles

AVSA



AZRA



AZRA
Numaralı



BERGAMA



BEYZA



BURGAZ



C ÇİFTLİ



ÇEŞME



BERGAMA
40X20



BERGAMA
50X10



BERGAMA
Siyah 50X10



BERRAK



EBRU



DEFNE



DEMRE



DEMRE
Saten



PASLANMAZ ÇEKME KOLLAR

Stainless Pull Handles

DEMRE

40X20



DİRSEK



EBRU



EFES



ESMA



FOÇA



GALAXY



GÖKÇE



EFES

Saten



EFLİN



EFLİN

Lama



EFLİN

Saten



GİZEM

Saten



GÖKÇE



İLGİN



İREM

Krom Saten



PASLANMAZ ÇEKME KOLLAR

Stainless Pull Handles

İREM
Saten



IZGARA



LİDYA



MANAVGAT



MİLAS



P 42



BORU
Çap 30



BORU



MANYAS
Çift çizgili



MANYAS



MERCAN



MİLAS
Krom saten



PİRAMİT

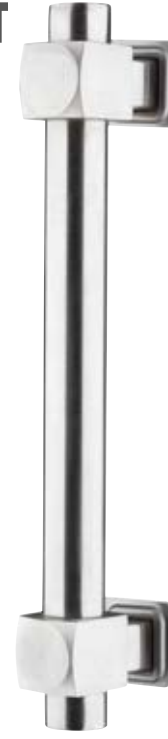

RÜZGAR



SÜMELA



TUTKU



PASLANMAZ ÇEKME KOLLAR

Stainless Pull Handles

VENÜS



ULUS



YAPRAK



ALİMİNYUM ÇEKME KOLLAR

Aluminium Pull Handles

NAKIŞLI

Saten



NAKIŞLI

Siyah



OSMANLI



PİPO



RENKLER

Colors

SATEN

SARI

Yellow

RENKLER

Colors

SATEN

SARI

Yellow

ALİMİNYUM

Büyük Kol



ALİMİNYUM

Küçük Kol



KAPI TOKMAKLARI

Door Knockers

ALTI KÖŞE

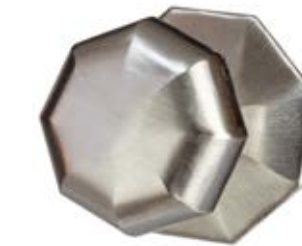

KRİSTAL



YUVARLAK



KARE





KAPI
TAK-
TAKLARI
DOOR
KNOCKERS

ALUMİNYUM TAKTAKLAR

Aluminum Knockers

NAKIŞLI

Saten



NAKIŞLI

Siyah



HALKA

Siyah



VAZO



AJDA

Geniş



AJDA

Küçük



KUMRU



SAFİR



RENKLER

Çiğir

● SİYAH Black ● SATEN Saten ● SARI Yellow

RENKLER

Çiğir

● SİYAH Black ● SATEN Saten ● SARI Yellow

RENKLER

Çiğir

● SATEN Saten ● SARI Yellow

RENKLER

Çiğir

● SATEN Saten ● SARI Yellow

MOBAKS



DAMLA

Saten



RENKLER

Çiğir

● SATEN Saten ● SARI Yellow

PİRİNÇ TAKTAKLAR

Brass Mattets

KARAMAN



SARAY



HAVZA



KRİSTAL



ZAMAK TAKTAKLAR

Zamak Knockers

BALCO MOON



ZAMAK



MOON



İMAJ



MOBAKS





ANTIQUE
ANTIIK
GRUP GROUP

ANTİK KAPI AKSESUARLARI

Antique Door Handles



ANTİK KAPI AKSESUARLARI

Antique Door Handles





STEEL BADGE ●

ÇELİK RÖZET

TAS GRUBU

ÇELİK ROZETLER

Steel Badge

KLASİK



- RENKLER
Colors
- SATEN Saten
 - SARI Yellow
 - SIYAH Black
 - KROM Crom

MENEKŞE



- RENKLER
Colors
- SATEN Saten
 - SARI Yellow
 - SIYAH Black
 - KROM Crom

IRMAK



- RENKLER
Colors
- SATEN Saten
 - SARI Yellow
 - SIYAH Black
 - KROM Crom

KARDELEN



- RENKLER
Colors
- SATEN Saten
 - SARI Yellow
 - SIYAH Black
 - KROM Crom

KARE



- RENKLER
Colors
- SATEN Saten
 - SARI Yellow
 - SIYAH Black
 - KROM Crom

ORKİDE



- RENKLER
Colors
- SATEN Saten
 - SARI Yellow
 - SIYAH Black
 - KROM Crom

YASEMİN



- RENKLER
Colors
- SATEN Saten
 - SARI Yellow
 - SIYAH Black
 - KROM Crom

ZAMBAK



- RENKLER
Colors
- SATEN Saten
 - SARI Yellow
 - SIYAH Black
 - KROM Crom

MENEKŞE



ÇELİK ROZETLER VE TAS

Steel Badge

PLASTİK GIYDİRME



ÇELİK PASLANMAZ



KALE MODEL



KROM



SATEN



SIYAH



ORKİDE



PASLANMAZ TAS



SARI TAS





HIDDEN CLAMP

KELEPÇE GRUBU

GİZLİ EMNİYET KELEPÇESİ

Hidden Safety Shackle

BALCO

Kare Paslanmaz Mandal



BALCO

Yuvarlak Paslanmaz Mandal



ZAMAK

Mandal



ALUMİNYUM MANDAL



ALUMİNYUM KARE

Mandal



ZAMAK KARE

Mandal



RENKLER

● SIYAH *Black* ● SATEN *Saten* ● SARI *Yellow*

GİZLİ MANDAL MEKANİZMASI



OLUŞUM GİZLİ KELEPÇE



OLUŞUM SÜRGÜ



KLASİK KELEPÇE

Saten



HDF PLASTİK ÜRÜNLER

Hdf Plastic Products

HDF 01



HDF 02



HDF 03



HDF 04



HDF 05



HDF 06



HDF 09



DEMKA KİLİT KARŞILIĞI

Demka Lock Provision

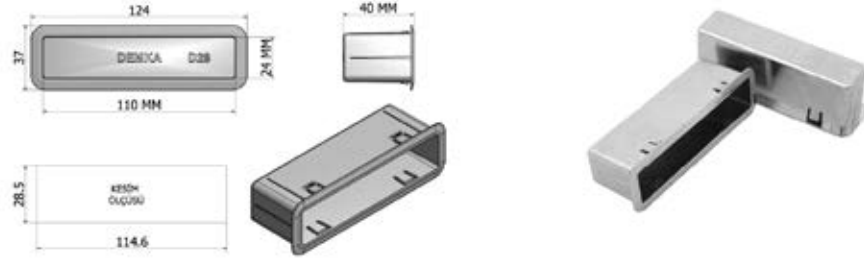

D28
TAKMATİK KİLİT KARŞILIĞI
PLASTİK 24x110

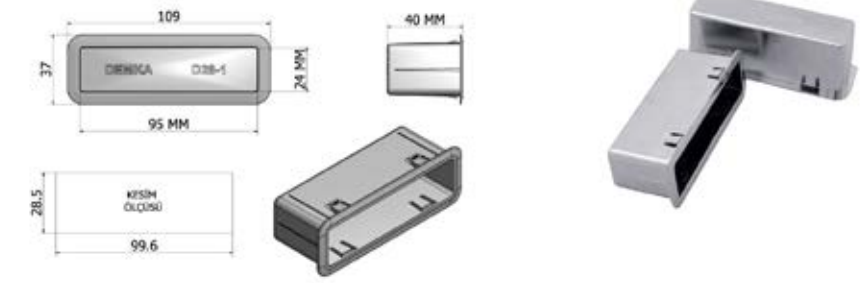

D28.1
TAKMATİK KİLİT KARŞILIĞI
PLASTİK 24x95

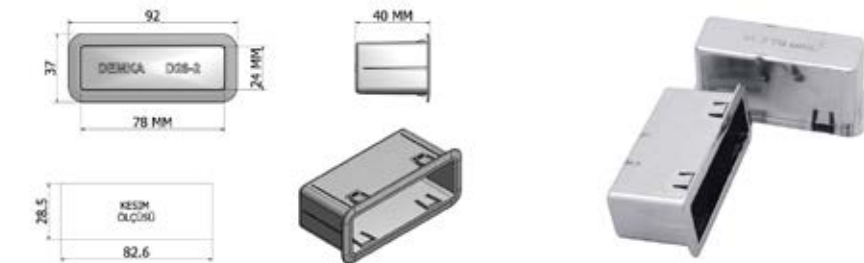

D28.2
TAKMATİK KİLİT KARŞILIĞI
PLASTİK 24x78

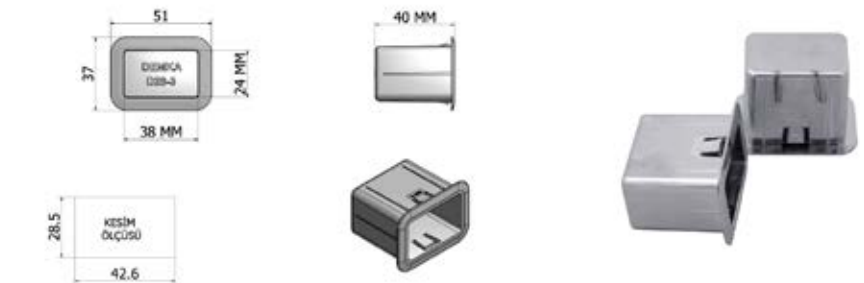

D28.3
TAKMATİK KİLİT KARŞILIĞI
PLASTİK 24x38

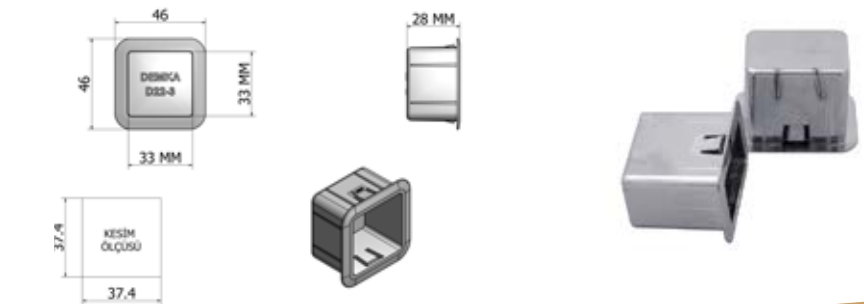

D22.3
TAKMATİK KİLİT KARŞILIĞI
PLASTİK 33x33

DEMKA KİLİT KARŞILIĞI

Demka Lock Provision

D21.1.1

AYARLANABİLİR DİL KARŞILIĞI
NİKEL CİVATALI
ADJUSTABLE TONGUE
PROVISION NICKEL BOLTED



D20.0

EMNİYET MEKANİZMASI KARŞILIĞI
PASLANMAZ TAKIM
STAINLESS TOOL FOR
SAFETY MECHANISM



D20

SLIDING SAFETY CLAMP
SÜRGÜLÜ EMNİYET KELEPÇESİ





BINOCULARS

DÜRBÜN

VE İSİMLİK TAG GROUP

GRUBU

DÜRBÜN VE İSİMLİK

Door Binoculars and Tag

60X90/60X110

Dürbün



RENKLER

SIYAH Black SATEN Saten SARI Yellow

35X60/50X75/50X90

Dürbün



RENKLER

SIYAH Black SATEN Saten SARI Yellow

PUL

Dürbün Pulu



RENKLER

SATEN Saten SARI Yellow

PUL

Dürbün Pulu Prinç



RENKLER

SATEN Saten SARI Yellow

PUL

Büyük Dürbün Pulu Prinç



RENKLER

SATEN Saten SARI Yellow

PUL

Dürbün Pulu Zamak



RENKLER

SATEN Saten SARI Yellow

5X3/8X3/11X3 İSİMLİK



RENKLER

SATEN Saten SARI Yellow

YALE VE FİYAM ROZET



RENKLER

SATEN Saten SARI Yellow

İTHAL UZATMA



PRİNÇ UZATMA



ELEKTRONİK DÜRBÜNLER

Electronic Door Binoculars

DESi

Kayıtsız Kameralı Dürbün



FONRİ

Kameralı Dürbün



YALE

Kayıtlı Dürbün



YALE

Kayıtsız Dürbün



balcioglu.net

BALCIOĞLU
HİRDAVAT

128 • 129



PANICBAR AND FIRE
MATERIAL

PAN!K BAR

VE YANGIN MALZEMESİ

İÇ KİLİT PANİK BAR TAKIMLARI

Interior Lock Panic Bar Sets

DEMKA

■ Teknik Çizim - D19 İç Kilit

▶ PATENT NO: 2015/13536 - 2015/ 13535

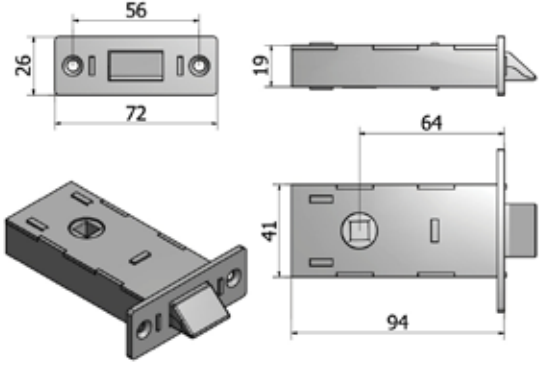

TURKMALI



TS EN 1125
365B1322AA
375A1322AA



D1915
PANİK İÇ KİLİT TAKIMI İMZA 41 LİK SİYAH



D1915.3
PANİK İÇ KİLİT TAKIMI İMZA 41 LİK GRİ

Dış Müdahale

■ Teknik Çizim

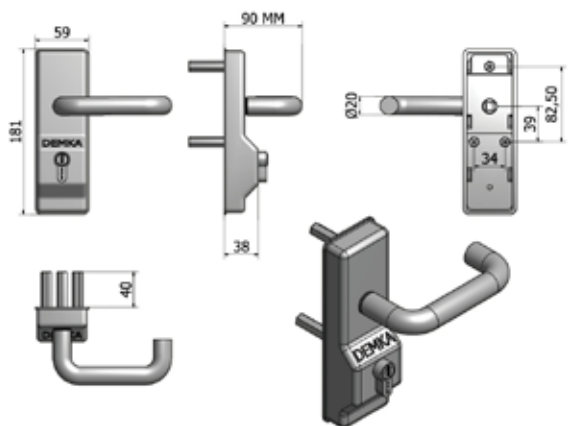

D16
ÇELİK GÖVDELİ SİYAH DIŞ
MÜDAHALE



D16.1
ÇELİK GÖVDELİ GRİ DIŞ
MÜDAHALE

D16.3
ÇELİK GÖVDELİ KIRMIZI
DIŞ MÜDAHALE

İÇ KİLİT PANİK BAR TAKIMLARI

Interior Lock Panic Bar Sets

DEMKA



- Türk Standartları Enstitüsü tarafından test edilip onaylanmış olup TSE belgelidir.
- Sağ sol açılımlı kapılarda kullanıma uygundur.
- Gövde ve kol çeliktir.
- Oval profil kol çeliktir.

▶ TASARIM TESCİL BELGE NO: 2014/03027

▶ PATENT NO: 2014/04272 - 2015/ 13535

■ Teknik Çizim - D1815

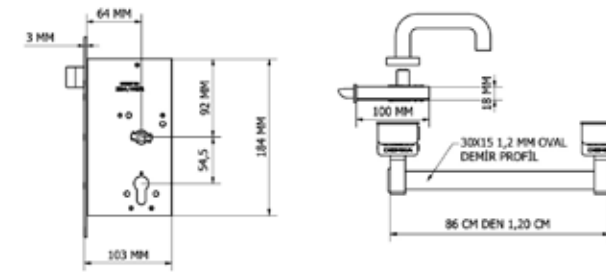
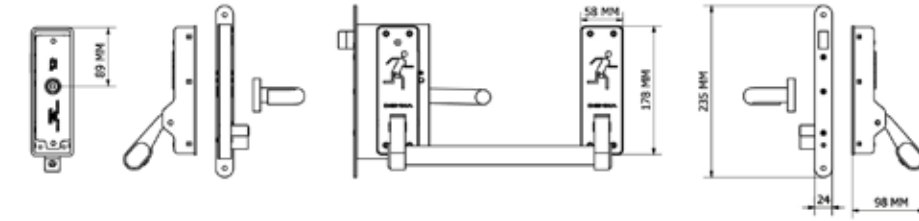

D1815
PANİK İÇ KİLİT TAKIMI 184 LÜK SİYAH

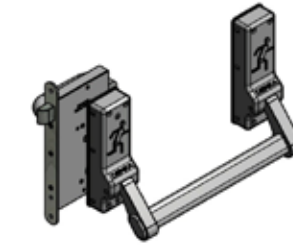

D1815.3
PANİK İÇ KİLİT TAKIMI 184 LÜK GRİ

TURKMALI



TS EN 1125
365B1322AA
375A1322AA

ÇELİK GÖVDELİ PANİK BAR

Steel Body Panic Bar

DEMKA



D1517.1
ÇELİK GÖVDELİ SİYAH PANİK
BAR KILIFLI



D17
PANİK BAR KILIFI SİYAH



D17.1
PANİK BAR KILIFI NİKEL

ÇİFT KANAT PANİK BAR SİSTEMLERİ

Double Wing Panic Bar Systems

- ▶ TASARIM TESCİL BELGE NO: 2015/03938
- ▶ PATENT NO: 2015/11003

■ Teknik Çizim

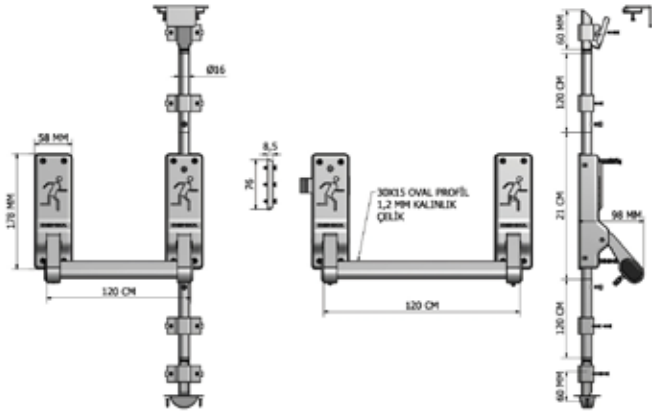

D1715.01
ÇİFT KANAT SİYAH PANİK BAR

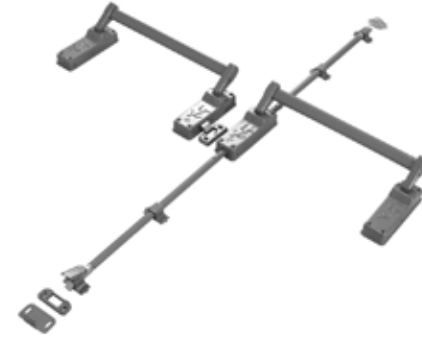

D1715.05
ÇİFT KANAT GRİ PANİK BAR



TS EN 1125
365B1322AA
375A1322AA

ÇELİK GÖVDELİ PANİK BAR

Steel Body Panic Bar

DEMKA



TS EN 1125
365B1322AA
375A1322AA

- Türk Standartları Enstitüsü tarafından test edilip onaylanmış olup TSE belgelidir.
- Sağ sol açılımlı kapılarda kullanıma uygundur.
- Gövde ve kol çeliktir.
- Oval profil kol çeliktir.

▶ TASARIM TESCİL BELGE NO: 2013/00475

■ Teknik Çizim

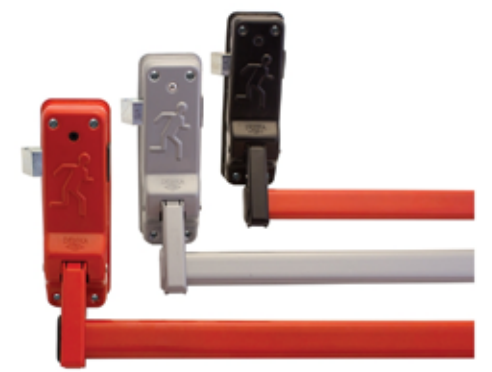
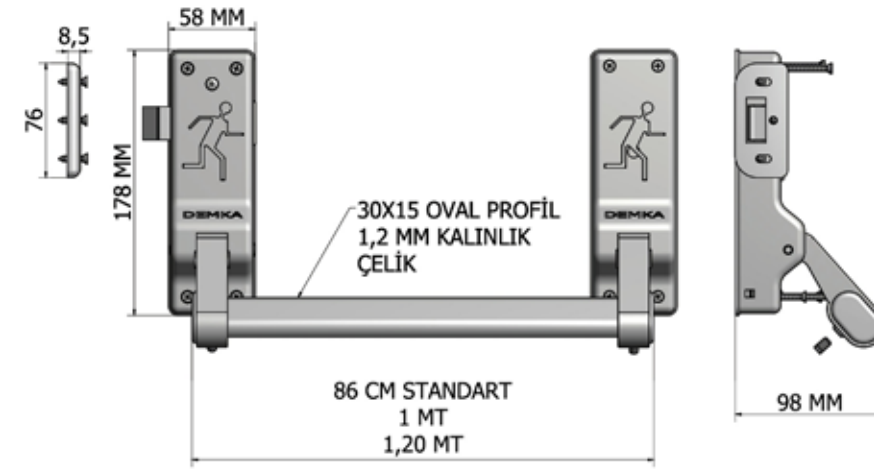

D15
ÇELİK GÖVDELİ SİYAH PANİK BAR



D15.3
ÇELİK GÖVDELİ GRİ PANİK BAR



D15.4
ÇELİK GÖVDELİ KIRMIZI PANİK BAR

ÇELİK GÖVDELİ İÇ KİLİT PANİK BAR

Steel Body Internal Lock Panic Bar

DEMKA

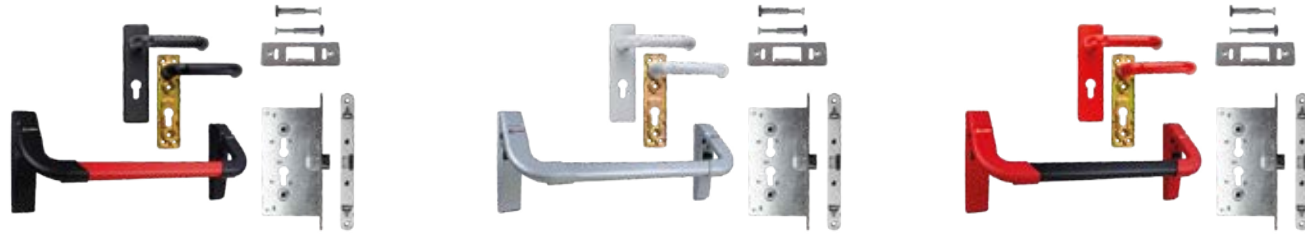
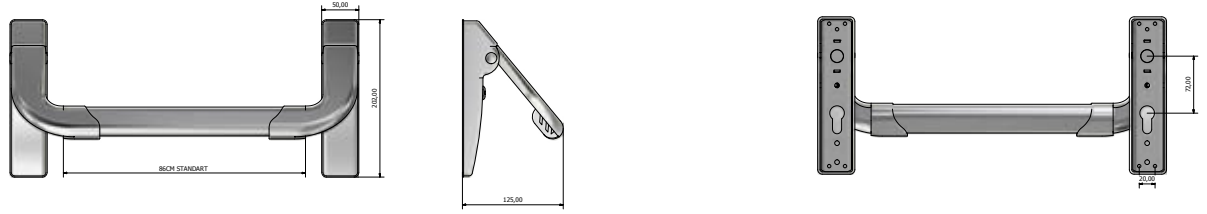

D100 İç Kilit Sistemli Panik Bar ve Kol Takımı Siyah / Panic Bar and Handle Set with Internal Lock System Black

D100.1 İç Kilit Sistemli Panik Bar ve Kol Takımı Gri / Panic Bar and Handle Set with Internal Lock System Grey

D100.2 İç Kilit Sistemli Panik Bar ve Kol Takımı Kırmızı / Panic Bar and Handle Set with Internal Lock System Red

ÇELİK GÖVDELİ PANİK BAR

Steel Body Panic Bar

DEMKA



D101 İç Kilit Sistemine Uyumlu Panik Bar Siyah / Panic Bar Compatible with Internal Lock System Black

D101.1 İç Kilit Sistemine Uyumlu Panik Bar Gri / Panic Bar Compatible with Internal Lock System Grey

D101.2 İç Kilit Sistemine Uyumlu Panik Bar Kırmızı / Panic Bar Compatible with Internal Lock System Red



PANİK BAR UYUMLU YÖNSÜZ İÇ KİLİT SİSTEMİ

Panic Bar Compatible Non-directional Internal Lock System

DEMKA

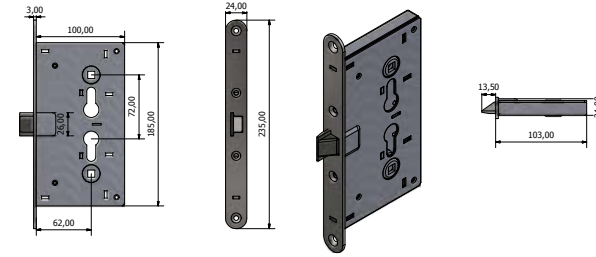

Bu ürün tr2019/02848 patent numarası ile korunmaktadır.
This product is protected under tr2019/02848 patent number.



D102 Panik Bar Uyumlu Yönsüz İç Kilit Sistemi / Panic Bar Compatible with Non-Directional Internal Lock System



D103 Panik Bar Uyumlu Yönsüz İç Kilit Sistemi Mızraklı / Panic Bar Compatible with Non-Directional Internal Lock System with Shaft

DIŞ MÜDAHALE

Foreign Intervention

DEMKA

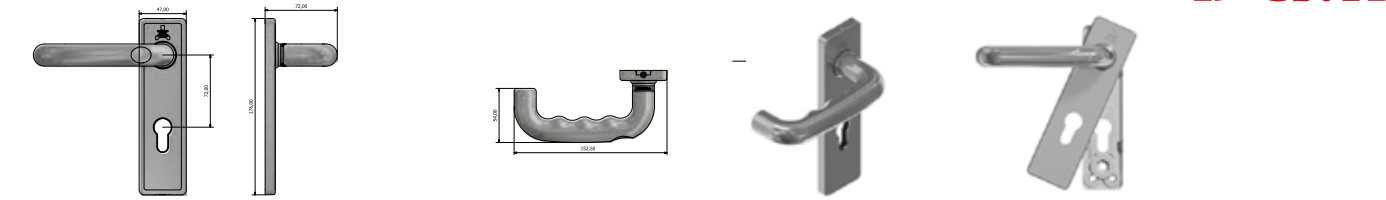

D104 Metal üzeri plastik kaplamalı kapı kolu barel yuvalı siyah renk / Plastic coated metal doorknob with barrel slot black



D104.1 Metal üzeri plastik kaplamalı kapı kolu barel yuvalı gri renk / Plastic coated metal doorknob with barrel slot grey



D104.2 Metal üzeri plastik kaplamalı kapı kolu barel yuvalı kırmızı renk / Plastic coated metal doorknob with barrel slot red



D105 Metal üzeri plastik kaplamalı barelsiz kapı kolu siyah renk / Plastic coated metal doorknob without barrel slot black



D105.1 Metal üzeri plastik kaplamalı barelsiz kapı kolu gri renk / Plastic coated metal doorknob without barrel slot grey



D105.2 Metal üzeri plastik kaplamalı barelsiz kapı kolu kırmızı renk / Plastic coated metal doorknob without barrel slot red

PANIKBAR VE YANGIN MALZEMESİ

Panicbar and Fire Material



50 M

Baretsiz Kol



55 M

Barelli Kol



66 M

Paslanmaz Kol



66 M

Siyah Paslanmaz Kol



50 M

Yanmaz Topuz Kol



210 E

Kilitsiz Kol



220 E

Kilitli Kol



660 GK

Gömme Sertifikalı Kilit



660 GKP

Pasif Kanat Gömme Kilit



660 GKN

Mızraklı Kilit



PANIKBAR VE YANGIN MALZEMESİ

Panicbar and Fire Material



200 E

Panik Bar



550 E

Çift Kanat



550 D

Panik Bar



600 GPL

Panik Bar



ELEKTROMANYETİK

Kilit



GIYOTİN



L BARET

Manyetik Tutucu



MANYETİK

TUTUCU



OMNİ

Yarım Bareller



MENTEŞE

OMNİ Yangın Kapısı Menteşesi



ADAPTÖR

Sıralama Adaptörü



PANIKBAR VE YANGIN MALZEMESİ

Panicbar and Fire Material



KD040-30-270

Push Bar Çift Kanat Panikbar



KD040-30-220

Push Bar Tek Kanat Panikbar



KD040-30-280

Panik Bar



KD040-30-291

Kilitli Kol



A 201

Panik Bar



A 201 ÇK

Panik Bar



ÇELİK

Panik Bar



K 301

Kilitli Kol



ERKAL

DİKEY

Çift Kanat Panik Bar



YATAY

Panik Bar



KİLİTLİ KOL

Panik Bar Kolu



ÇELİK GÖVDELİ PANİK BAR

Steel Body Panic Bar



PB 2000

Panikbar



FORELLİ

Panik Bar



FORELLİ KOL

Panik Bar Kolu





DOOR SEALS

KAPI FITİLLERİ

KAPI FİTİLLERİ

Door Seals



EPDM G 03

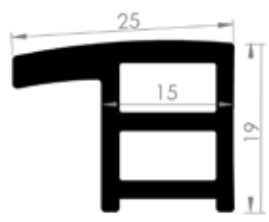

EPDM G 04

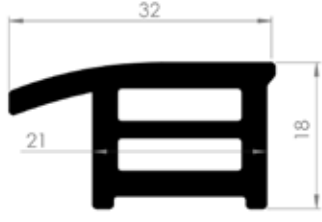

EPDM G 05

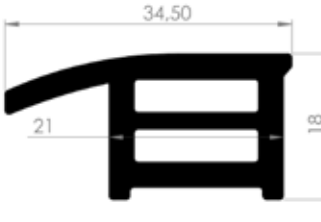

EPDM G 06

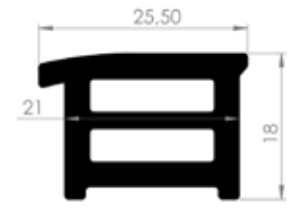

ÇELKA 01

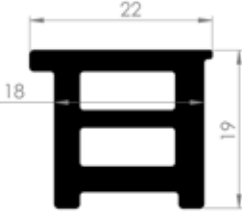

ÇKA

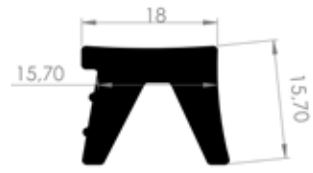

EPDM

Z Fitol

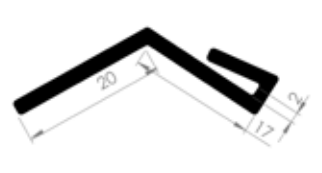

EŞİK

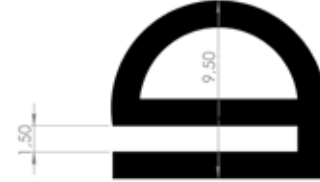

PANEL KÜP

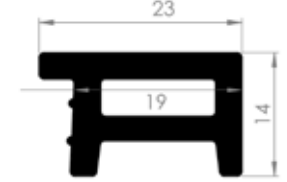

VB 02-U



VB TİP

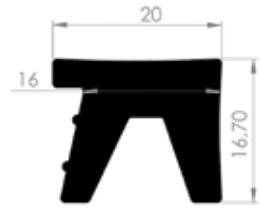

VB-02 TİP

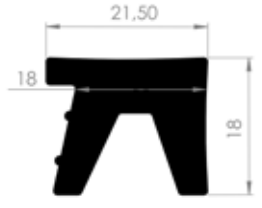

VB-U TİP

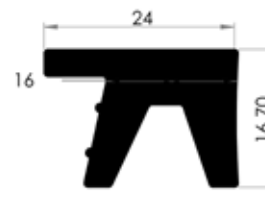

VP-U TİP

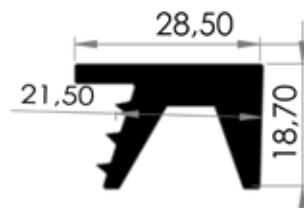

V TİP PANEL

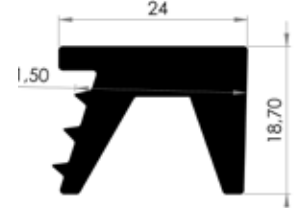

VS TİP

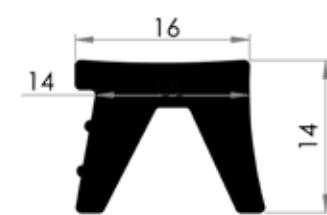

VS U

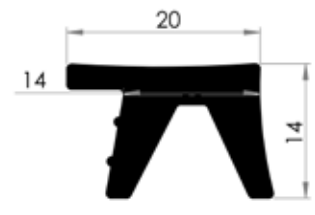

P-20



ÇLK-40



KAPI FİTİLLERİ

Door Seals



ASM-01

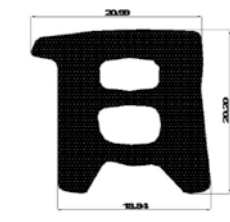

BAL-04



BAL-07

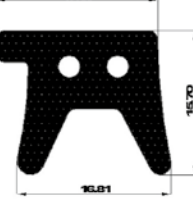

ÇELKA 01

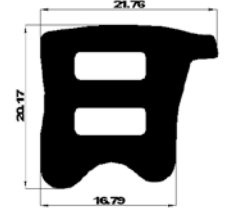

ÇKA 01-1

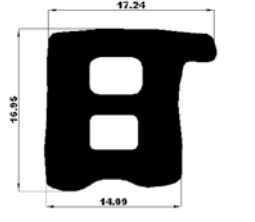

ÇKA 101

Bantlı Fitol



ÇKA 01

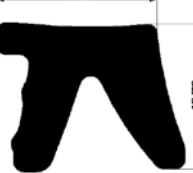

ÇKA 05-2



EFOR 01

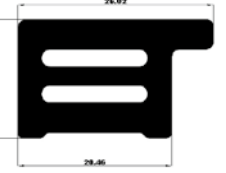

EFOR 03

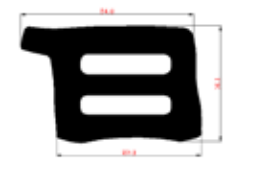

HASKA 02

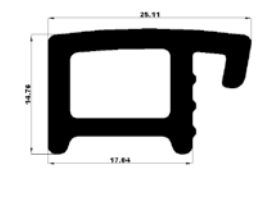

HASKA 03



HASKA 04



HASKA 07



HASKA 08



K-05

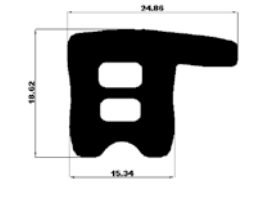

K-06

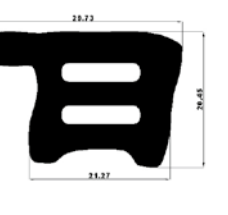

K-08

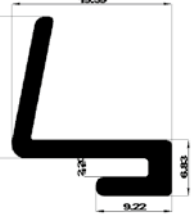

M 02



UYGUN 04

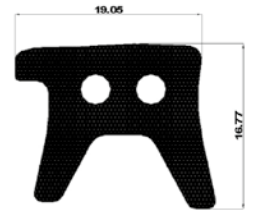

KAPI FİİLLERİ

Door Seals



M 05

Eşik Fİili

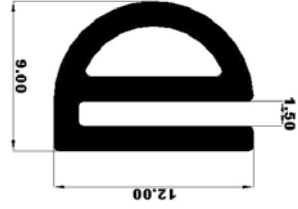

ŞIK 01

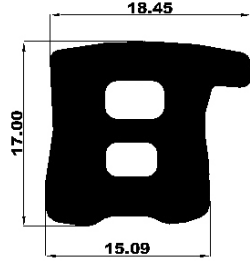

M-06

Bantlı Lama Fİil

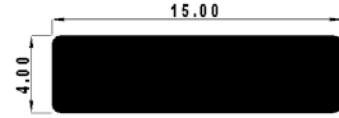

BALCO BANTLI FİİLLER SİYAH - KAHVE - BEYAZ

Banded Wicks

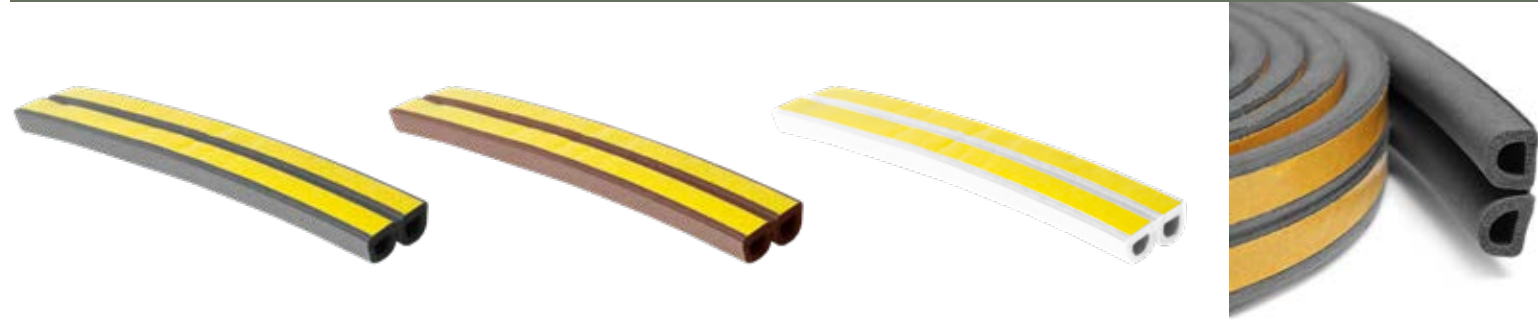

BANTLI FİİLLER 2-3-4-5X15-18-20-22-25

Banded Wicks

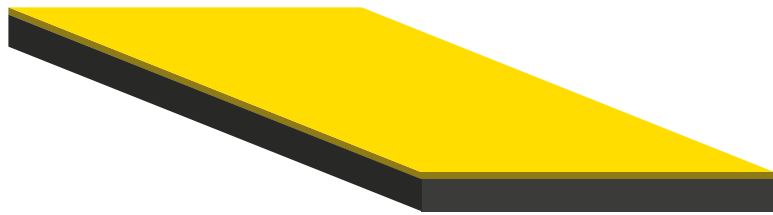

DUMAN SIZDIRMAZ KAPI FİİLLERİ

Door Seals

1X15

Yapışkan Bantlı Yangın Kapi Contası

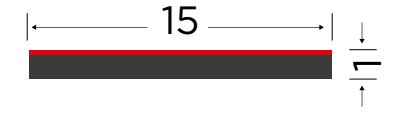
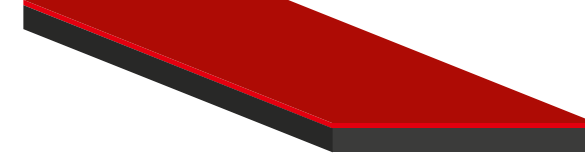

1X20

Yapışkan Bantlı Yangın Kapi Contası

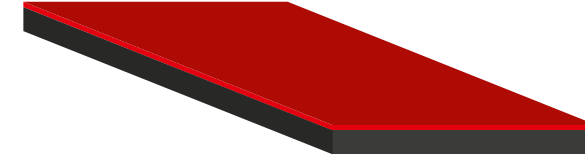

1X25

Yapışkan Bantlı Yangın Kapi Contası

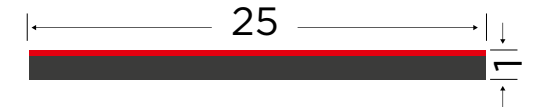
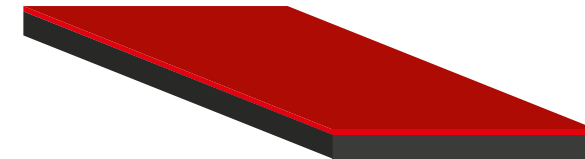

YKC-25

Yangın Kapi Contası

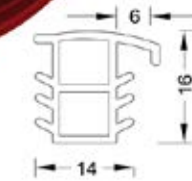
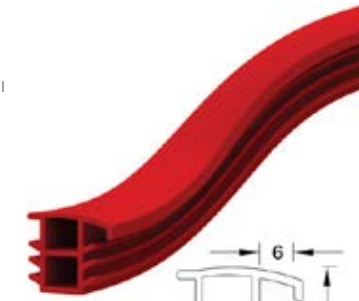



HINGE GROUP

MENTESE GRUBU

ÇELİK KAPI MENTEŞELERİ

Steel Door Hinges

Kullanım yeri : Hafif ve ağır çelik kapılar
Kapı yönü : Sağ ve sol uyumludur
Kapı ağırlığı Max : 100 kg
İç mil çapı : 11mm
Et kalınlığı : 3 mm
Toplam boy ölçüsü : 103 mm
Kaplama : Galvaniz

Menteşenin özelliği

- Profesyonel düşünener için ayarlı menteşeler mevcuttur.
- Kapı yüzeyine ister kaynaklı ister vidalı sistemde montaj edilebilir
- Vidalı menteşeler imalatta kaynaklı çalışmayı kaldırarak hızlı bir imalat akışı sağlar.
- Kapı yüzeyinde estetik ve şık bir görüntü sağlar.
- Menteşeye ek olarak plastik kılıf ile nikel veya saten görüntüsü sağlanabilir.

■ Teknik Çizim

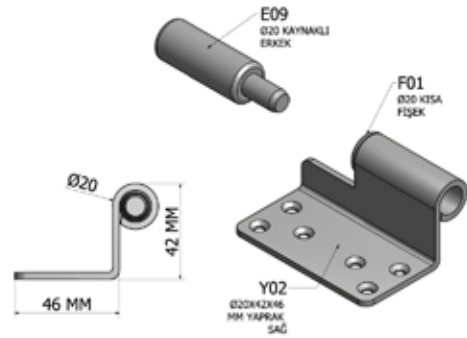

D01
EKONOMİK KAYNAKLI MENTEŞE
Ø20x42 MM

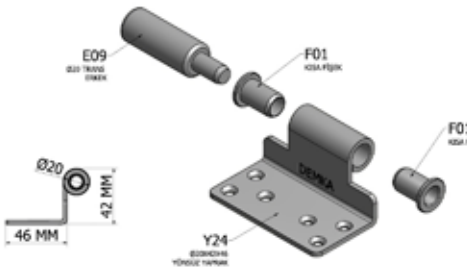

D01.S
EKONOMİK KAYNAKLI YÖNSÜZ
MENTEŞE Ø20x42 MM

ÇELİK KAPI MENTEŞELERİ

Steel Door Hinges

■ Teknik Çizim

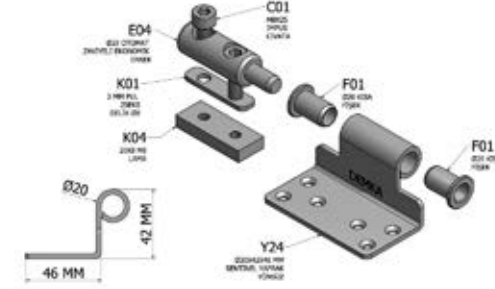

D02.S
M8 SIKMALI EKONOMİK
YÖNSÜZ MENTEŞE Ø20x42 MM

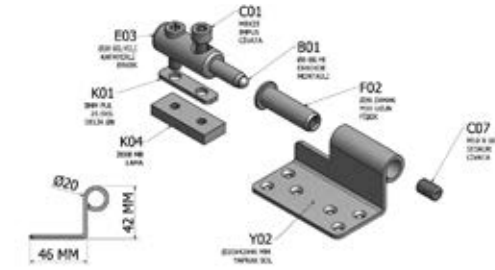

D03
AŞAĞI YUKARI M8 SIKMALI
MENTEŞE Ø20x42 MM

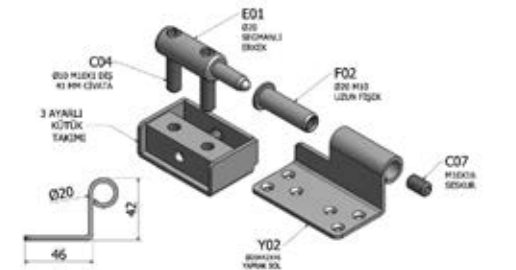

D05
ÜÇ YÖNDE AYARLI MENTEŞE
Ø20x42 MM

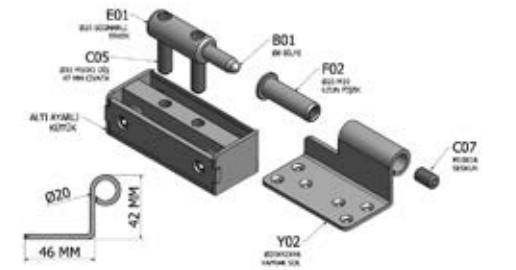

D06
ALTI YÖNDE AYARLI MENTEŞE
Ø20x42 MM



ÇELİK KAPI MENTEŞELERİ

Steel Door Hinges

■ Teknik Çizim



D02.AD5.A
AŞAĞI YUKARI M8 SIKMALI ÇEKME
MENTEŞE Ø20x42 MM

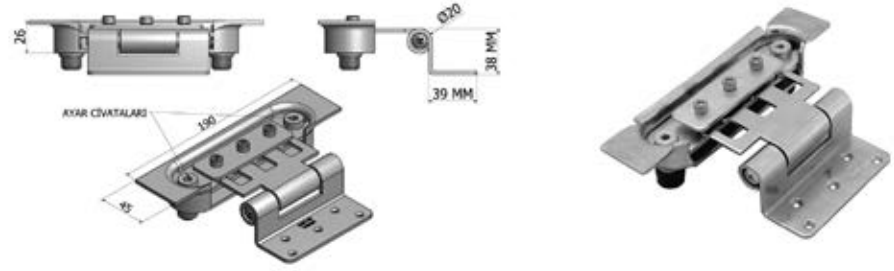

D09
HER YÖNDE AYARLI SAC MENTEŞE

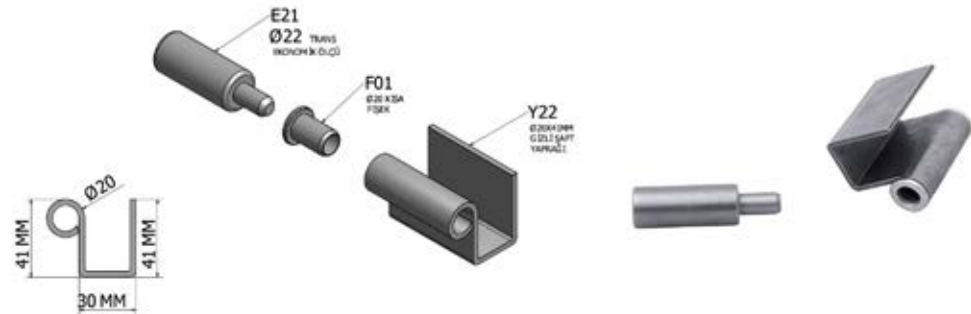

Y22
Ø20x41 MM ŞAFT KAPI
MENTEŞESİ GİZLİ YAPRAK

YAYLI YANGIN KAPI MENTEŞELERİ

Spring Fire Door Hinges

Kullanım Yeri	: Yangın kapıları
Kapı Yönü	: Sağ ve sol uyumludur
Donanım	: Yaylı menteşe
Kapı Ağırlığı Max	: 80 Kg
İç Mil Çapı	: 15 mm
Et Kalınlığı	: 3 mm
Toplam Boy Ölçüsü	: 186 mm
Patent Numarası	: TR2010 -08312

Menteşenin Özelliği

- Yangın kapıları için menteşe içinde bulunan yay ile kapatmayı sağlayan bir üründür.
- Kapı yüzeyine (kanat-kasa) ister kaynaklı ister vidalı sistem ile montaj edilebilir.
- Kolay kurulumu ile birlikte şık bir görüntü sağlar.
- Yay kurulduktan sonra kapı kanadının en fazla 120 derece açılması tavsiye edilir.
- 120 dereceden fazla açılan kapıların arkasına stoplama konulması tavsiye edilir.

■ Teknik Çizim

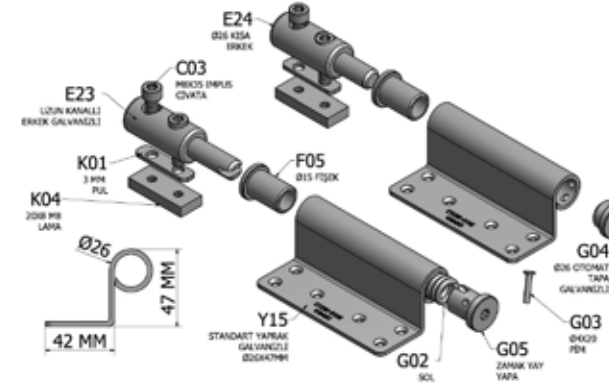

D07
YAYLI YANGIN KAPISI MENTEŞESİ
Ø26x47 MM

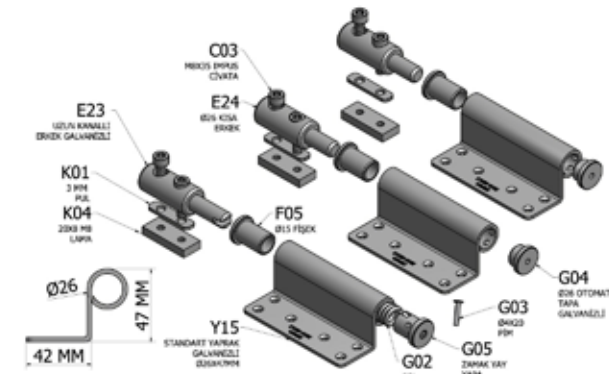

D07.1.1
YAYLI YANGIN KAPISI MENTEŞESİ
Ø26x47 MM ÜÇ YAPRAK



T.C.
TÜRK PATENT ENSTİTÜSÜ
İNCELEMELİ PATENT
No: TR 2010 08312 B

YAYLI YANGIN KAPI MENTEŞELERİ

Spring Fire Door Hinges

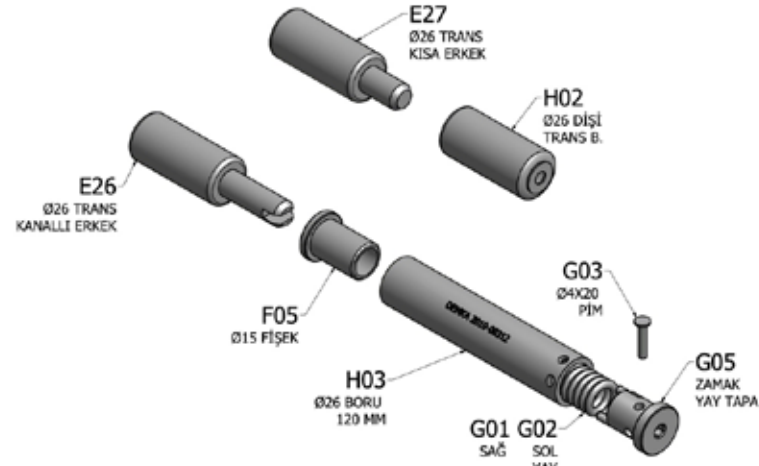

D07.9B
YAYLI YANGIN KAPISI MENTEŞESİ
Ø26 BORU KAYNAKLI

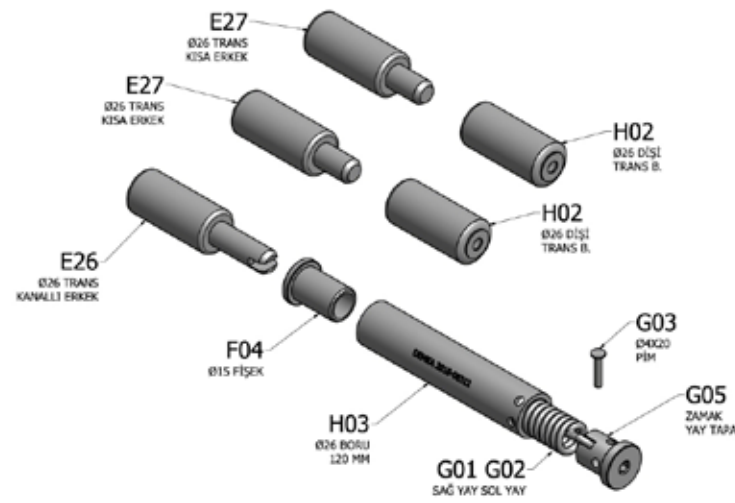

D07.9B1
YAYLI YANGIN KAPISI MENTEŞESİ Ø26
BORU KAYNAKLI İKİ MİLLİ

YAYLI YANGIN KAPI MENTEŞELERİ

Spring Fire Door Hinges

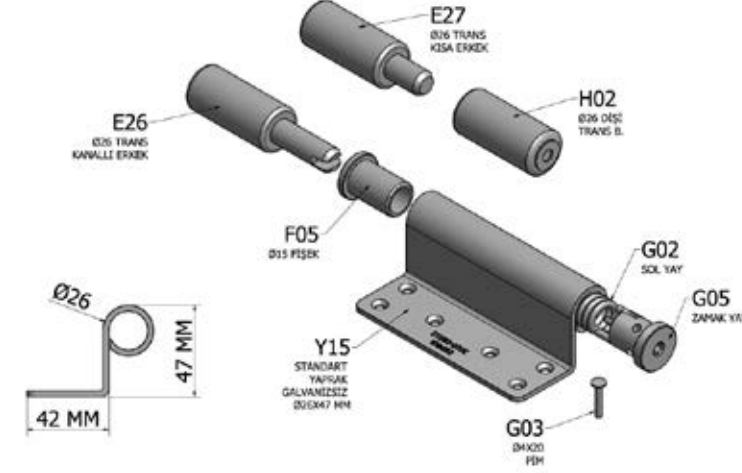

D07.5
YAYLI YANGIN KAPISI MENTEŞESİ
Ø26x47 MM KAYNAKLI

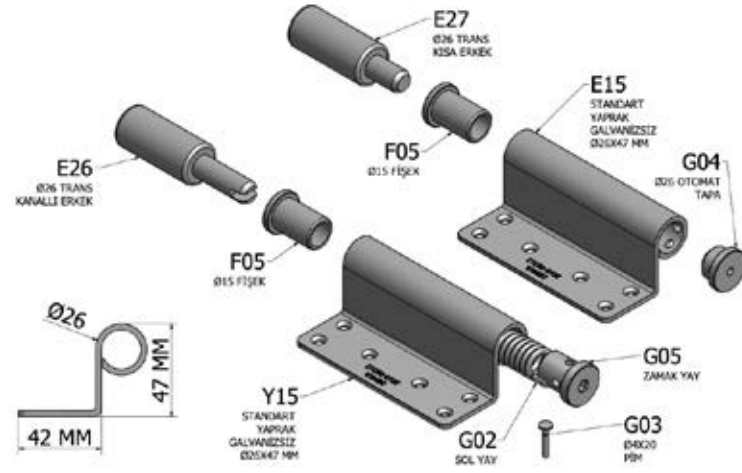

D07.7
YAYLI YANGIN KAPISI MENTEŞESİ
Ø26x47 MM KAYNAKLI

STANDART MENTEŞE

Standard Hinges

14-16-18-20-22 MM STANDART MENTEŞE



BİLYALI MENTEŞE



YAYLI MENTEŞE



PROFİL MENTEŞESİ



KELEBEK MENTEŞE



MENTEŞE KILIFLARI

Hinge Cases

D 59

Menteşe Kilifi
Pasltik Nikel
Ø29x70x51

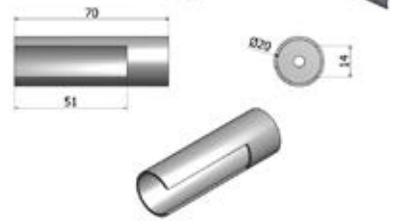

D 61

Menteşe Kilifi
Pasltik Nikel
Ø20x73,5x71,5

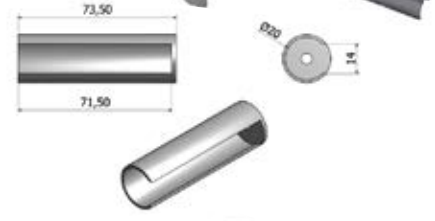

D 62

Menteşe Kilifi
Pasltik Nikel
Ø20x54x52,4

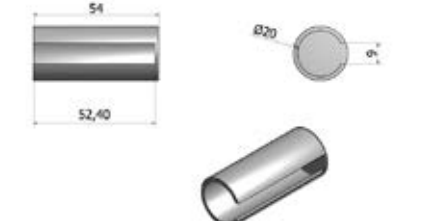

D 63

Menteşe Kilifi
Pasltik Nikel
Ø20x51x49,5x15

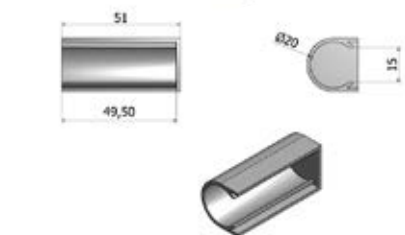

D 64

Menteşe Kilifi
Pasltik Nikel
Ø20x52,4x50,4

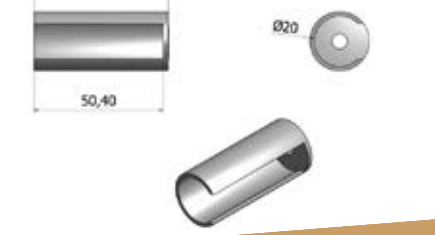

SÜRGÜLER

Catches

LÜKS MANDALLI



ÇELİK İTMELİ



KİLİTLİ GÖMME



KROM





OTHER PRODUCT
GROUP

DiĐER
ÜRÜN
GRUBU

DIĞER ÜRÜN GRUPLARI

Other Product Group



GENEL AMAÇLI
SİLİKON



POLİÜRETAN
KÖPÜK



MONTAJ KÖPÜĞÜ



DENİZ TUTKALI



MİTRE APEL
YAPISTIRICI



HIZLI YAPISTIRICI



SIVI ÇİVİ



EMNİYET PİM GRUBU

Safety Pin Group

14'LÜK PİM



16'LİK PİM



18'LİK PİM



DIĞER ÜRÜN GRUPLARI

Other Product Group

VİDA ÇEŞİTLERİ



- 3,9*16
- 3,9*19
- 3,9*22
- 3,9*25
- 3,9*32
- 3,9*38

VİDA BAŞLIĞI

SATEN



KROM



ALYANLI AYIPÖRTEN



KABLO MUHAFAZA YAYI



SAPLAMA



SOMUN



AYIPÖRTEN



DİĞER ÜRÜN GRUPLARI

Other Product Group



GOLD FLAPDİSK ZIMPARA



INOX KESİCİ



METAL KESİCİ



ZR FLAPDİSK ZIMPARA



TAŞLAMA



PALET ZIMPARA



DİĞER ÜRÜN GRUPLARI

Other Product Group

KAYNAK TELİ

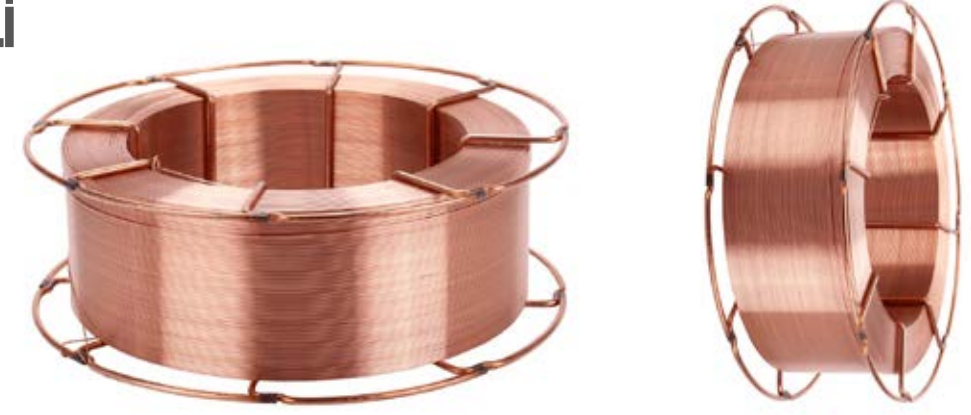

AMBALAJ ŞERİDİ



AMBALAJ TOKASI



İZOCAM



TAŞ YÜNÜ



DIĐER ÜRÜN GRUPLARI

Other Product Group

ŐILTE



PERVAZ ŐILTESİ



MENTEŐE ŐILTESİ



SERAMİK YÜNÜ



ALÇIPAN

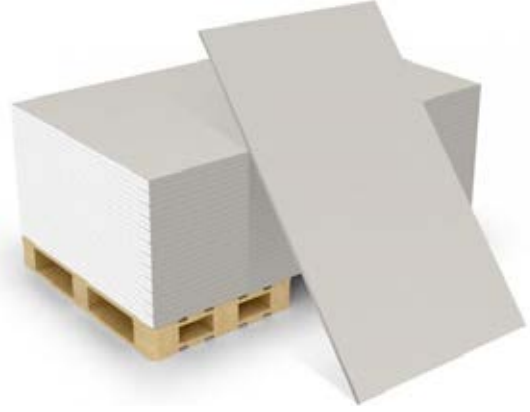

LEVHA KARTON



**AKSESUAR
KUTUSU**



KOLİ BANDI



NİTRİL ELDİVEN



KOT ELDİVEN





BALCIOĞLU
HIRDAVAT

Baskı ve dizgiden kaynaklanan hatalardan firmamız sorumlu değildir.
Balcioglu Hirdavat A.Ş. haber vermeksizin ürün özellikleri ve fiyatlarında değişiklik yapma hakkına sahiptir.
Bu katalogtaki kampanya fiyatları ve ürünler stoklarla sınırlıdır.

*Our company is not responsible from press and arranging order of this catalogue.
Balcioglu Hirdavat A.Ş. has right to change prices of products with out informing.
These prices are only for products which are available in stock.*



📍 Organize San.Böl. 21.Cad. No:26 Melikgazi / KAYSERİ
☎ 444 80 93 / +90 352 321 20 90 / 📠 +90 352321 20 94
✉ info@balcioglu.net

www.balcioglu.net